

FCI Molded Products Inc.



PRODUCTS



BUMPERS

PAGE 7-12



TEFLON GLIDES

PAGE 13-18



FELT PADS

PAGE 19-22



NAIL GLIDES

PAGE 23-28



FELT GLIDES

PAGE 29-32



CAPS

PAGE 33-36



FLOOR PROTECTORS

PAGE 37-38



SWIVEL GLIDES

PAGE 39-46



LEVELERS

PAGE 47-60



THREADED ADAPTERS

PAGE 61-64



INDUSTRIAL LEVELERS

PAGE 65-68



KNOBS/HANDLES

PAGE 69-70



INSERT GLIDES

PAGE 71-80



CUSTOM MOLDED PARTS

PAGE 81-84



SELF-ADHESIVE BUMPERS

PAGE 7-12

FCI carries a full line of self-adhesive bumpers for every application. Our peel resistant technology creates a long lasting bond to almost any clean, dry surface. These bumpers are abrasion and skid resistant and will not mark, scratch or stain almost any surface. The adhesive is engineered to not harden or break over time. Available in clear, black or brown on either sheets or rolls.

TEFLON GLIDES

PAGE 13-18

FCI has a complete line of 'PTFE' slider glides designed to easily glide over almost any surface. This material is one of the slipperiest substances ever developed and has one of the lowest coefficients of friction of any solid material.

PTFE is completely unaffected by outdoor weathering and will operate in extremely high and low temperatures (-240°C to +260°C).



FELT PADS

PAGE 19-22

FCI has self-adhesive felt pads for every application. Designed specifically to protect hardwood floors and furniture, these pads come in a multitude of shapes and sizes and can be supplied on both sheets and rolls. Our long lasting felt is available in various materials such as fiberfloss, wool, EVA, heavy duty as well as cork. These pads are available in black, white, grey, brown and beige and can be custom cut to your specific requirements.

NAIL GLIDES

PAGE 23-28

At FCI we carry an extensive line of nail glides to cover all your needs. For more than 20 years we have been manufacturing nail glides from wear resistant plastics with numerous bases such as metal, felt, PTFE, rubber etc. Our welding process ensures that our felt bases will not peel off in almost any application. These nail glides are available in many sizes, shapes and colors. Additionally we can custom manufacture these glides to your specific needs.





FELT GLIDES

PAGE 29-32

FCI has developed a process of co-molding felt to plastic which creates an exponentially stronger bond than traditional glues. This bond will not be weakened by temperature or humidity. These felt based glides are available in many styles to fit all types of wood, metal or plastic furniture. Designed to protect all types of smooth flooring, the felt glides allow furniture to easily slide over many non-abrasive surfaces.

CAP GLIDES

PAGE 33-36

Cap glides are designed to fit over tubing and are available in a vast array of sizes and materials. These outside fitting caps/glides can be molded from PVC, TPR, PP and come in light and heavy duty specifications for all types of applications. These glides will protect all types of flooring from hardwood to slate and tile. These glides come in white, black, grey and clear. FCI is capable of matching any Pantone colour.



FLOOR PROTECTORS

PAGE 37-38

FCI's easy-to-use Floor Protectors can be placed under the legs of furniture to prevent both floor and carpet damage. They can also be used to prevent casters from rolling.



SWIVEL GLIDES

PAGE 39-46

FCI has one of the most extensive selection of swivel glides in North America. We carry swivel glides for almost any size and shaped tubing in both imperial and metric. Our basic swivel glides have been engineered to withstand a 300lb pull-out test when properly installed in the correct size tubing. Swivel glides are available in numerous styles and shapes with various types of bases from plastic to metal to felt and come in all types of finishes. FCI can also custom manufacture swivel glides to your specific needs & requirements.

LEVELERS

PAGE 47-60

For over 25 years, FCI has been the primary supplier to some of the largest furniture manufacturers in the world. From residential to commercial, office furniture to store fixtures, appliances to upholstered goods, we have the leveller/adjustable glide you need. We can manufacture almost any size in both imperial and metric. Bases are available in all types of plastics from nylon to poly to metal in sliding PTFE, non-slip TPV or non-marring felt. The leveler studs are made from steel and zinc plated to resist corrosion. Studs can be fixed or swivel and custom fabricated to any configuration you may require.



THREADED METAL ADAPTERS

PAGE 61-64

Threaded metal adapters eliminate the expensive process of welding female threaded inserts into tube ends. Once installed these adapters are virtually non-removable creating a permanent re-usable thread for levellers etc. Available in both imperial and metric for almost any size round, square and rectangular tubing, these adapters come in many designs for light duty and heavy duty applications. Additionally, they can be threaded for levellers or non-threaded for friction fit caster stems.

INDUSTRIAL LEVELERS

PAGE 65-68

Industrial levellers are designed for heavier applications such as machinery or over-sized equipment and furniture. These robust levellers have either plastic bases made from PA66 nylon or high strength carbon steel. Industrial levellers are designed to absorb machinery vibration and can come with non-slip pads to keep heavy structures stable.





KNOBS, LEVERS & HANDLES

PAGE 69-70

FCI has a very broad selection of control knobs for every application. From T-style to 3, 4 & 5 point star knobs in varying types of plastics. These knobs come with studs or internal threads in both imperial and metric. Knobs can be over-molded with a soft touch material to create a comfortable, non-slip gripping surface. If you don't see what you need in our catalog please inquire as we have many styles not in this catalog. FCI is capable of custom manufacturing any control knob or handle you may require in an assortment of materials and sizes.

INSERT GLIDES & BUMPERS

PAGE 71-80

Insert glides are designed to fit inside your tubing leaving a practically invisible closure. We have glides for almost every size and shaped tubing whether it's round, square, oval or rectangular. Also in this section you will find bumpers and plastic threaded adapters for any application. FCI will also custom mold any insert glide from a multitude of materials in any color.



CUSTOM MOLDING & DIE-CASTING

PAGE 81-84

FCI has become one of the largest suppliers of custom molded plastic parts and zinc / aluminum die-cast parts. From as low as \$1000.00 we can create a custom tool to produce your uniquely designed part for any application. You design the part and send us a drawing, sketch or sample of what you want and we will make it. Small minimum quantities allow anyone to make custom parts. Pre-production samples are supplied for approval prior to any production run. Parts can be molded from any plastic material or die-cast from zinc or aluminum. FCI can also supply stamped metal parts from CRS or any other sheet metal material upon request.

BUMPER HPB SERIES

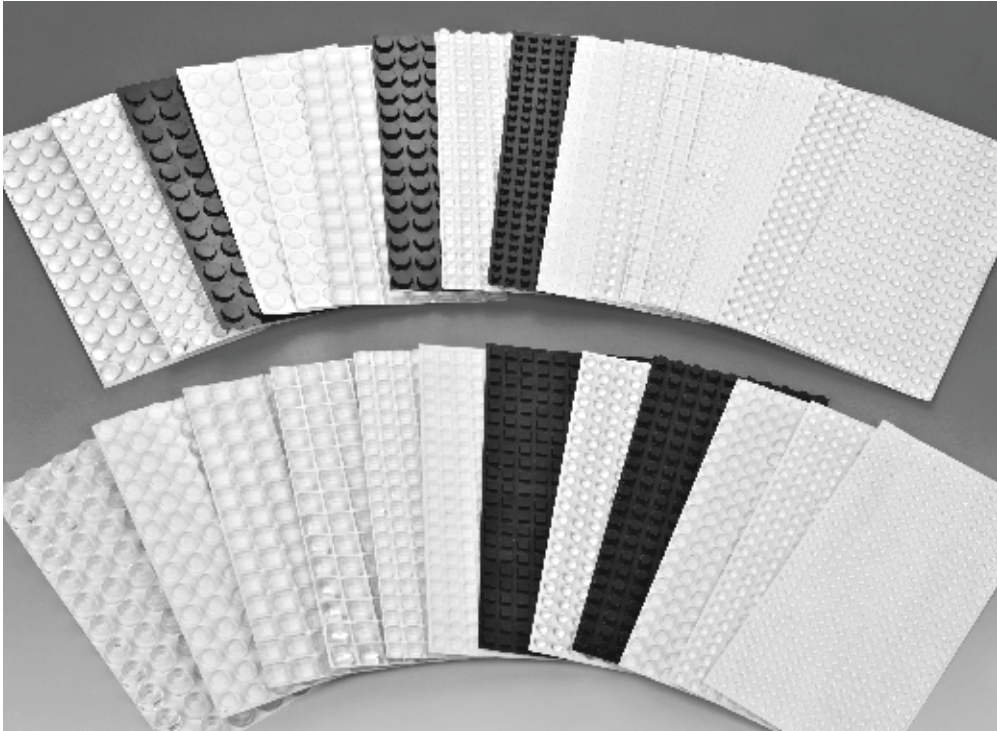

Cylindrical

HPB-1 0.125"
(3.2mm)

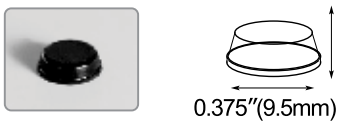

0.375"(9.5mm)

300/Sheet-6000Per Box

HPB-2 0.190"
(4.8mm)



0.375"(9.5mm)

288/Sheet-7200Per Box

HPB-3 0.200"
(5.1mm)



0.440"(11.1mm)

242/Sheet-5082Per Box

HPB-4 0.060"
(1.5mm)

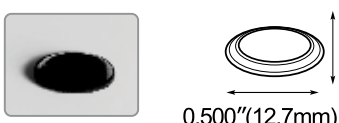

0.500"(12.7mm)

200/Sheet-5000Per Box

HPB-5 0.140"
(3.5mm)

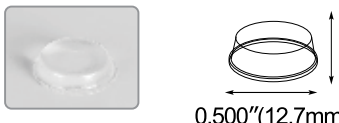

0.500"(12.7mm)

200/Sheet-5000Per Box

HPB-6 0.250"
(6.4mm)

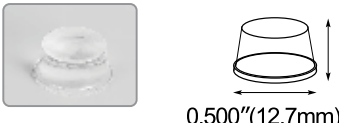

0.500"(12.7mm)

200/Sheet-5000Per Box

HPB-7 0.160"
(4.1mm)



0.750"(19.1mm)

98/Sheet-2450Per Box

HPB-8 0.200"
(5.1mm)

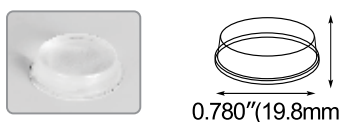

0.780"(19.8mm)

98/Sheet-3430Per Box

HPB-9 0.120"
(3.0mm)

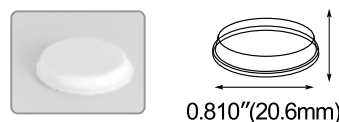

0.810"(20.6mm)

72/Sheet-2520Per Box

Hemispherical

HPB-23 0.085"
(2.2mm)

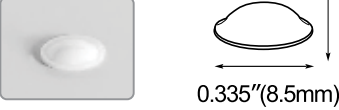

0.335"(8.5mm)

450/Sheet-11250Per Box

HPB-24 0.150"
(3.8mm)



0.375"(9.5mm)

288/Sheet-7200Per Box

HPB-25 0.211"
(5.4mm)

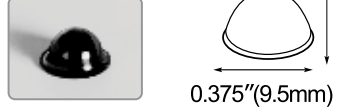

0.375"(9.5mm)

300/Sheet-6000Per Box

HPB-26 0.310"
(7.9mm)

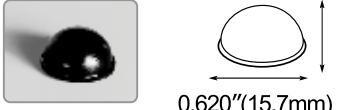

0.620"(15.7mm)

128/Sheet-3200Per Box

HPB-27 0.380"
(9.6mm)



0.700"(17.8mm)

98/Sheet-2254Per Box

HPB-28 0.075"
(1.9mm)



0.750"(19.1mm)

98/Sheet-5096Per Box

HPB-29 0.118"
(3.0mm)

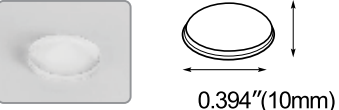

0.394"(10mm)

288/Sheet-7200Per Box

HPB-30 0.083"
(2.1mm)

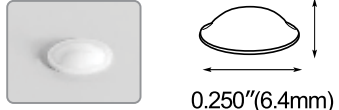

0.250"(6.4mm)

578/Sheet-15028Per Box

Square

HPB-50 0.100"
(2.5mm)

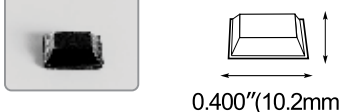

0.400"(10.2mm)

242/Sheet-5082Per Box

HPB-51 0.120"
(3.0mm)

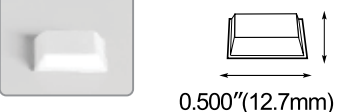

0.500"(12.7mm)

200/Sheet-5000Per Box

HPB-52 0.230"
(5.8mm)

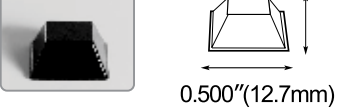

0.500"(12.7mm)

200/Sheet-5000Per Box

HPB-53 0.250"
(6.4mm)



0.780"(19.8mm)

98/Sheet-2940Per Box

HPB-55 0.300"
(7.6mm)

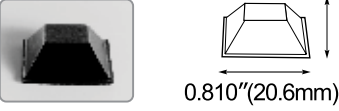

0.810"(20.6mm)

98/Sheet-2646Per Box

CUSTOM SIZES AND SHAPES ARE AVAILABLE



**Rollstock meets
your unique
requirements,
beyond
shape & size.**

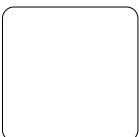

BUMPER HPB SERIES

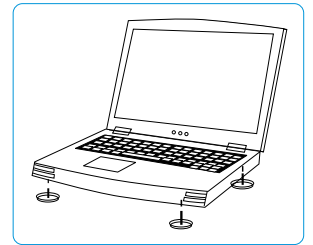
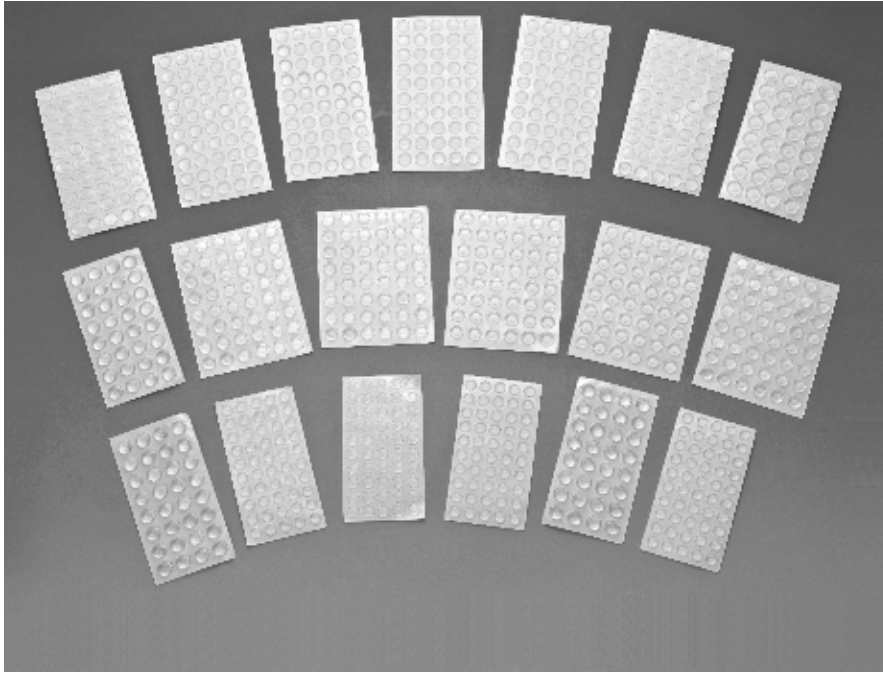

Cylindrical

HEB-1 0.140"
(3.5mm)

0.394"(10mm)

48/Sheet-9600Per Box

HEB-2 0.140"
(4mm)

0.500"(12mm)

32/Sheet-6400Per Box

HEB-3 0.140"
(4mm)

0.500"(12mm)

28/Sheet-6400Per Box

HEB-10 0.188"
(3.0mm)

0.394"(10mm)

50/Sheet-10000Per Box

HEB-11 0.140"
(3.5mm)

0.500"(12.7mm)

32/Sheet-6400Per Box

HEB-12 0.110"
(2.8mm)

0.500"(12mm)

36/Sheet-7200Per Box

HEB-13 0.160"
(4.1mm)

0.750"(19.1mm)

36/Sheet-7200Per Box

BUMPER HEB SERIES

Hemispherical

HEB-21 0.059"
(1.5mm)

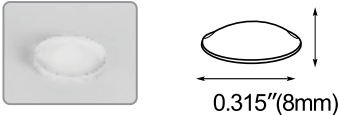

0.315"(8mm)

50/Sheet-10000Per Box

HEB-22 0.100"
(2.5mm)

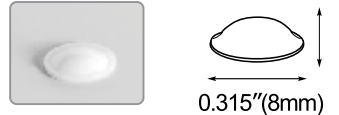

0.315"(8mm)

50/Sheet-10000Per Box

HEB-24 0.059"
(1.5mm)

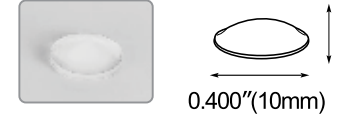

0.400"(10mm)

50/Sheet-10000Per Box

HEB-25 0.118"
(3.0mm)

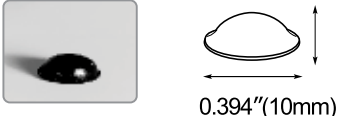

0.394"(10mm)

50/Sheet-10000Per Box

HEB-27 0.200"
(5.0mm)



0.394"(10mm)

32/Sheet-6400Per Box

HEB-30 0.310"
(7.9mm)



0.620"(15.7mm)

36/Sheet-7200Per Box

HEB-31 0.295"
(7.5mm)

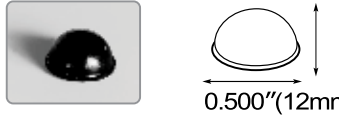

0.500"(12mm)

40/Sheet-4000Per Box

HEB-32 0.295"
(7.5mm)



0.500"(12.7mm)

36/Sheet-7200Per Box

Square

HEB-40 0.120"
(3.0mm)

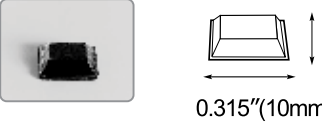

0.315"(10mm)

50/Sheet-10000Per Box

HEB-41 0.120"
(3.0mm)



0.500"(12.7mm)

32/Sheet-6400Per Box

HEB-45 0.250"
(6.4mm)



0.780"(19.8mm)

36/Sheet-7200Per Box

Recessed And Others

HEB-46 0.300"
(7.6mm)

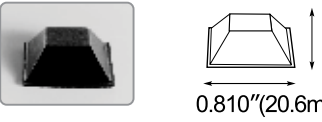

0.810"(20.6mm)

36/Sheet-7200Per Box

HEB-47 0.230"
(5.8mm)

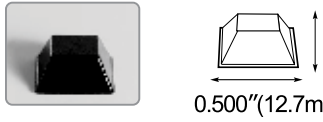

0.500"(12.7mm)

24/Sheet-4800Per Box

HEB-14 0.417"
(10.6mm)



0.900"(23mm)

16/Sheet-3200Per Box

TEFLON GLIDES



TEFLON GLIDES



Part No.	Specification	Thickness	Colour	Material
HPT-10	19mm	4mm	Gr,Br,Ye	PTFE
HPT-11	22mm	6mm	Gr,Br,Ye	PTFE
HPT-12	25mm	6mm	Gr,Br,Ye	PTFE
HPT-13	30mm	6mm	Gr,Br,Ye	PTFE
HPT-14	40mm	6mm	Gr,Br,Ye	PTFE
HPT-15	50mm	6mm	Gr,Br,Ye	PTFE
HPT-17	63mm	6mm	Gr,Br,Ye	PTFE



Part No.	Specification	Thickness	Colour	Material
HPT-30	22 x 22mm	6mm	Gr,Br,Ye	PTFE
HPT-31	24 x 35mm	6mm	Gr,Br,Ye	PTFE
HPT-32	30 x 30mm	6mm	Gr,Br,Ye	PTFE
HPT-34	24 x 100mm	6mm	Gr,Br,Ye	PTFE
HPT-36	40 x 40mm	6mm	Gr,Br,Ye	PTFE
HPT-37	45 x 45mm	6mm	Gr,Br,Ye	PTFE
HPT-38	50 x 50mm	6mm	Gr,Br,Ye	PTFE
HPT-39	19X70mm	6mm	Gr,Br,Ye	PTFE



Part No.	Specification	Thickness	Colour	Material
HPT-20	19mm	5mm	Gr,Br,Ye	PTFE
HPT-21	22mm	5mm	Gr,Br,Ye	PTFE
HPT-22	25mm	5mm	Gr,Br,Ye	PTFE
HPT-23	30mm	5mm	Gr,Br,Ye	PTFE
HPT-24	38mm	5mm	Gr,Br,Ye	PTFE
HPT-25	50mm	5mm	Gr,Br,Ye	PTFE



Part No.	Specification	Thickness	Colour	Material
HPT-41	25 x 25mm	5mm	Gr,Br,Ye	PTFE



Part No.	Specification	Thickness	Colour	Material
HPT-80	19mm	4mm	Gr,Br,Ye	PTFE
HPT-81	22mm	5mm	Gr,Br,Ye	PTFE
HPT-82	25mm	5mm	Gr,Br,Ye	PTFE
HPT-83	30mm	5mm	Gr,Br,Ye	PTFE
HPT-84	37mm	5mm	Gr,Br,Ye	PTFE
HPT-85	40mm	5mm	Gr,Br,Ye	PTFE



Part No.	Specification	Thickness	Colour	Material
HPT-86	24 x 24mm	6mm	Gr,Br,Ye	PTFE
HPT-87	24 x 35mm	6mm	Gr,Br,Ye	PTFE
HPT-88	37 x 37mm	6mm	Gr,Br,Ye	PTFE



Part No.	Specification	Thickness	Colour	Material
HPT-50	35x35x45mm	6mm	Gr,Br,Ye	PTFE
HPT-51	45x45x60mm	6mm	Gr,Br,Ye	PTFE
HPT-52	50x50x65mm	6mm	Gr,Br,Ye	PTFE
HPT-53	70x70x90mm	6mm	Gr,Br,Ye	PTFE



Part No.	Specification	Thickness	Colour	Material
HPT-150	65mm	13mm	Gr,Br,Ye	PTFE



Part No.	Specification	Colour	Material
HPT-70	19mm	Gr,Br,Ye	PTFE
HPT-71	22mm	Gr,Br,Ye	PTFE
HPT-72	25mm	Gr,Br,Ye	PTFE
HPT-73	28mm	Gr,Br,Ye	PTFE



Part No.	Specification	Colour	Material
HPT-160	19mm	Gr,Br,Ye	PTFE
HPT-161	22mm	Gr,Br,Ye	PTFE
HPT-162	25mm	Gr,Br,Ye	PTFE
HPT-163	28mm	Gr,Br,Ye	PTFE



Part No.	Specification	Colour	Material
HPT-170	Dia.22mm. M6x1"L	Gr,Br,Ye	PTFE
HPT-171	Dia.22mm. 1/4"-20Sx1"L	Gr,Br,Ye	PTFE
HPT-172	Dia.28mm. M6x1"L	Gr,Br,Ye	PTFE
HPT-173	Dia.28mm. 1/4"-20Sx1"L	Gr,Br,Ye	PTFE



Part No.	Specification	Colour	Material
HPT-60	Dia.30mm. M8x25mm	Gr,Br,Ye	PTFE
HPT-61	Dia.30mm. M8x35mm	Gr,Br,Ye	PTFE
HPT-62	Dia.30mm. M10x25mm	Gr,Br,Ye	PTFE
HPT-63	Dia.30mm. M10x35mm	Gr,Br,Ye	PTFE

EASY GLIDES SERIES



Part No.	Specification	Thickness	Colour	Material
HPT-100	19mm	4mm	Gr,Br,Ye	PTFE
HPT-101	22mm	6mm	Gr,Br,Ye	PTFE
HPT-102	25mm	6mm	Gr,Br,Ye	PTFE
HPT-103	30mm	6mm	Gr,Br,Ye	PTFE
HPT-104	40mm	6mm	Gr,Br,Ye	PTFE
HPT-105	50mm	6mm	Gr,Br,Ye	PTFE
HPT-106	65mm	6mm	Gr,Br,Ye	PTFE



Part No.	Specification	Thickness	Colour	Material
HPT-90	22 x 22mm	6mm	Gr,Br,Ye	PTFE
HPT-91	24 x 35mm	6mm	Gr,Br,Ye	PTFE
HPT-92	30 x 30mm	6mm	Gr,Br,Ye	PTFE
HPT-96	40 x 40mm	6mm	Gr,Br,Ye	PTFE

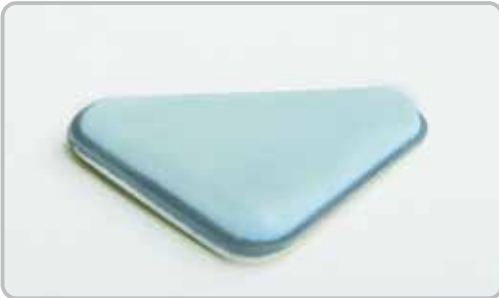

Part No.	Specification	Thickness	Colour	Material
HPT-110	35x35x45mm	6mm	Gr,Br,Ye	PTFE
HPT-111	45x45x60mm	6mm	Gr,Br,Ye	PTFE
HPT-112	50x50x65mm	6mm	Gr,Br,Ye	PTFE
HPT-113	70x70x90mm	6mm	Gr,Br,Ye	PTFE



Part No.	Specification	Thickness	Colour	Material
HPT-93	20 x 72mm	6mm	Gr,Br,Ye	PTFE
HPT-94	24 x 100mm	6mm	Gr,Br,Ye	PTFE
HPT-95	60 x 100mm	6mm	Gr,Br,Ye	PTFE

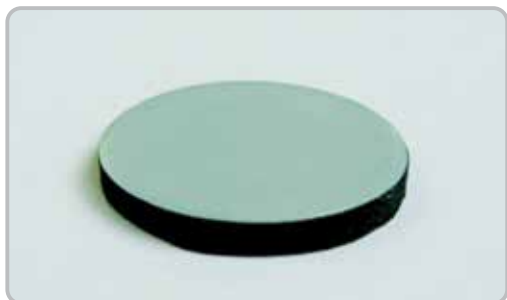

Part No.	Specification	Thickness	Colour	Material
HPT-120	17mm	1.5mm	Gr,Br,Ye	PTFE
HPT-121	22mm	1.5mm	Gr,Br,Ye	PTFE
HPT-122	24mm	1.5mm	Gr,Br,Ye	PTFE
HPT-123	28mm	1.5mm	Gr,Br,Ye	PTFE

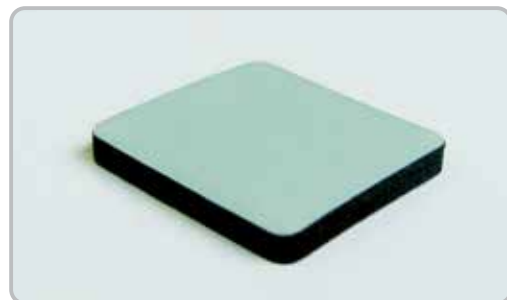

Part No.	Specification	Thickness	Colour	Material
HPT-130	22 x 22mm	1.5mm	Gr,Br,Ye	PTFE
HPT-131	24 x 24mm	1.5mm	Gr,Br,Ye	PTFE
HPT-132	28 x 28mm	1.5mm	Gr,Br,Ye	PTFE
HPT-133	80 x 100mm	1.5mm	Gr,Br,Ye	PTFE

FELT PADS





FELT PADS SERIES

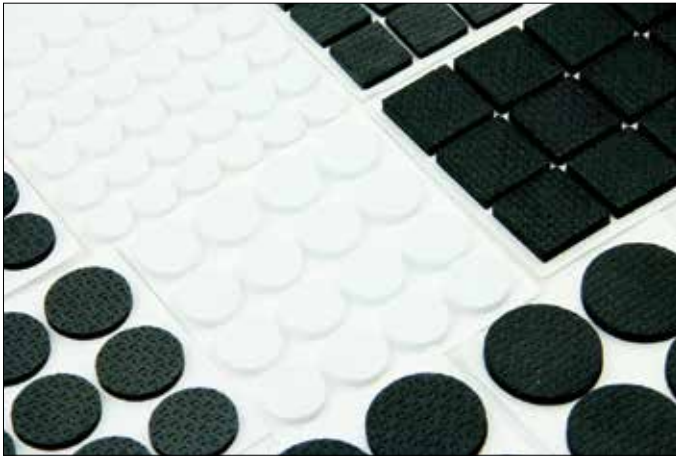

• **BLACK**



• **WHITE**



• **GREY**



• **BROWN**



• **BEIGE**

Part NO.	Size	PCS/Pad	Shape	Thickness	Colour	Packaging/Pad
HF10	10mm	32	Round	2mm/3mm	BL/WH/GR/BR	1000
HF15	15mm	30/36	Round/Square	2mm/3mm		1000
HF17	17mm	30	Round/Square	2mm/3mm		1000
HF19	19mm	12/16	Round/Square	2mm/3mm		1000
HF20	20mm	40/48/50	Round/Square	2mm/3mm		1000
HF22	22mm	16/50	Round/Square	2mm/3mm		1000
HF25	25mm	12/24/32	Round/Square	2mm/3mm		1000
HF28	28mm	12/28/32	Round/Square	2mm/3mm		1000
HF30	30mm	9/12/21	Round/Square	2mm/3mm		1000
HF35	35mm	6/12/18	Round/Square	2mm/3mm		1000
HF38	38mm	4/6/8	Round/Square	2mm/3mm		1000
HF40	40mm	12/10	Round/Square	2mm/3mm		1000
HF3555	35x55mm	12	Rectangle	2mm/3mm		1000
HF4090	40x90mm	5	Rectangle	2mm/3mm		1000
HF45	45mm	8	Round/Square	2mm/3mm		1000
HF55	55mm	7	Round/Square	2mm/3mm		1000
HF1224	120x240mm	1	Rectangle	2mm/3mm		1000

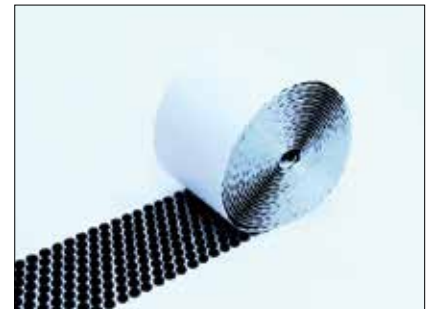

Part NO.	Size	PCS/Pad	Shape	Thickness	Colour	Packaging/Pad
HFZ10	10mm	5000	Round	2mm/3mm	BL/WH/GR/BR	24
HFZ13	13mm	4000	Round	2mm/3mm		24
HFZ16	16mm	4000	Round	2mm/3mm		24
HFZ20	20mm	3500	Round/Square	2mm/3mm		24
HFZ25	25mm	3000	Round/Square	2mm/3mm		24
HFZ38	38mm	2800	Round/Square	2mm/3mm		24
HFZ50	50mm	2500	Round/Square	2mm/3mm		24

NAIL GLIDES





NAIL GLIDES SERIES



Part No.	Size				Colour
	D	H	L	C	
120010	12.7mm	6mm	18mm	1.9mm	Brown/Natural
120011	15.8mm	6mm	18mm	1.9mm	Brown/Natural
120012	19mm	6mm	18mm	1.9mm	Brown/Natural
120013	22mm	6mm	18mm	1.9mm	Brown/Natural
120014	25.4mm	6mm	18mm	1.9mm	Brown/Natural
120015	28.6mm	6mm	18mm	1.9mm	Brown/Natural

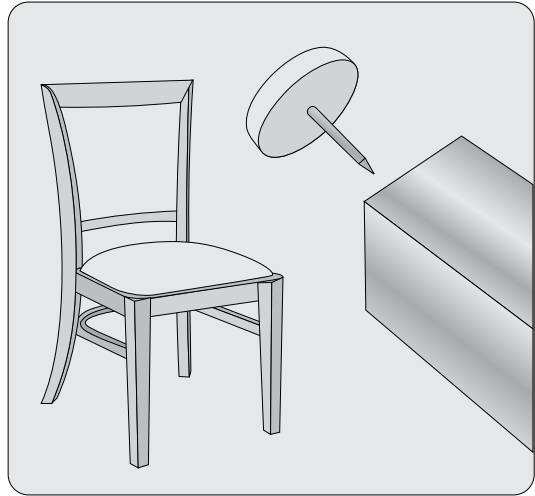

Part No.	Size				Colour
	D	H	L	C	
120020	12.7mm	6mm	18mm	1.9mm	Brown/Natural
120021	15.8mm	6mm	18mm	1.9mm	Brown/Natural
120022	19mm	6mm	18mm	1.9mm	Brown/Natural
120023	22mm	6mm	18mm	1.9mm	Brown/Natural
120024	25.4mm	6mm	18mm	1.9mm	Brown/Natural
120025	28.6mm	6mm	18mm	1.9mm	Brown/Natural



Part No.	Size				Colour
	D	H	L	C	
120030	12.7mm	10mm	19mm	2.6mm	Brown/Natural
120031	15.8mm	10mm	19mm	2.6mm	Brown/Natural
120032	19mm	10mm	19mm	2.6mm	Brown/Natural
120033	22mm	10mm	19mm	2.6mm	Brown/Natural
120034	25.4mm	10mm	19mm	2.6mm	Brown/Natural
120035	28.6mm	10mm	19mm	2.6mm	Brown/Natural



Part No.	Size				Colour
	D	H	L	C	
120050	15.8mm	5mm	18mm	1.9mm	Brown/Natural
120051	19mm	5mm	18mm	1.9mm	Brown/Natural

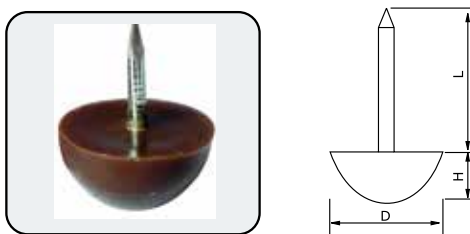

Part No.	Size				Colour
	D	H	L	C	
120060	1/2"	10mm	5/8"	1.9mm	Brown/Natural
120061	3/8"	10mm	5/8"	1.9mm	Brown/Natural
120062	5/8"	10mm	5/8"	1.9mm	Brown/Natural
120063	3/4"	10mm	5/8"	1.9mm	Brown/Natural

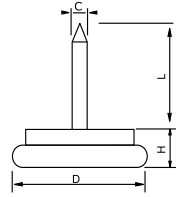

Part No.	Size				Colour
	D	H	L	C	
120120	19mm	10mm	18mm	2.6mm	Nickel
120121	22mm	10mm	18mm	2.6mm	Nickel
120122	24mm	10mm	18mm	2.6mm	Nickel
120123	27mm	10mm	18mm	2.6mm	Nickel
120124	30mm	10mm	18mm	2.6mm	Nickel

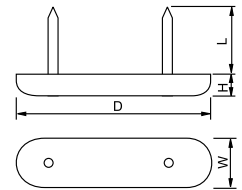
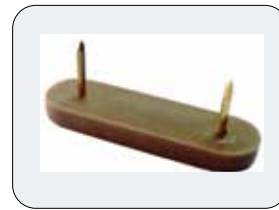

Part No.	Size				Colour
	D	W	H	L	
120090	2"	5/8"	1/4"	5/8"	Natural

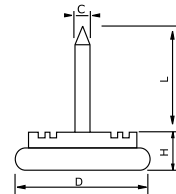

Part No.	Size				Colour
	D	H	L	C	
120120	19mm	10mm	18mm	2.6mm	Natural
120121	24mm	10mm	18mm	2.6mm	Natural
120122	27mm	10mm	18mm	2.6mm	Natural

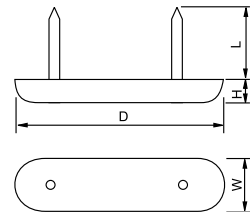

Part No.	Size				Colour
	D	W	H	L	
120100	2"	5/8"	1/4"	5/8"	Natural

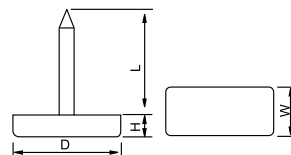

Part No.	Size				Colour
	D	W	H	L	
120080	3/4"	1-1/4"	1/12"	3/8"	Natural
120081	1-1/4"	1/2"	1/12"	3/8"	Natural



NAIL GLIDES SERIES

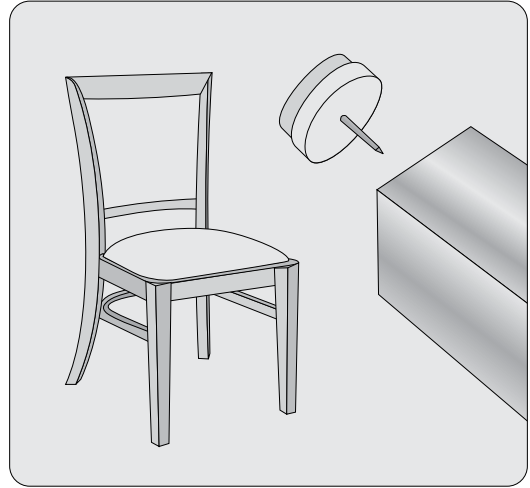
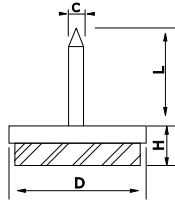

Part No.	Size				Colour
	D	H	L	C	
120160-1	17mm	9mm	14mm	1.6mm	Brown/Natural
120160	20mm	9mm	14mm	1.6mm	Brown/Natural
120161	22mm	9mm	14mm	1.6mm	Brown/Natural
120162	24mm	9mm	14mm	1.6mm	Brown/Natural
120163	28mm	9mm	14mm	1.6mm	Brown/Natural
120164	30mm	9mm	14mm	1.6mm	Brown/Natural

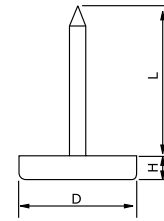
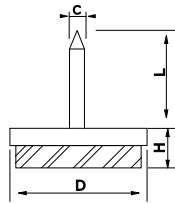

Part No.	Size				Colour
	D	H	L	C	
120201-1	17mm	8.5mm	15mm	1.9mm	Brown/Natural
120201	20mm	8.5mm	15mm	1.9mm	Brown/Natural
120202	22mm	8.5mm	15mm	1.9mm	Brown/Natural
120203	24mm	8.5mm	15mm	1.9mm	Brown/Natural
120204	28mm	8.5mm	15mm	1.9mm	Brown/Natural
120205	30mm	8.5mm	15mm	1.9mm	Brown/Natural

Part No.	Size				Colour
	D	H	L	C	
120040	3/4"	1/4"	18mm	1.9mm	Brown/Natural
120041	7/8"	1/4"	18mm	1.9mm	Brown/Natural
120042	1"	1/4"	18mm	1.9mm	Brown/Natural
120043	1-1/8"	1/4"	18mm	1.9mm	Brown/Natural

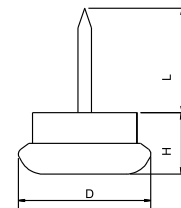
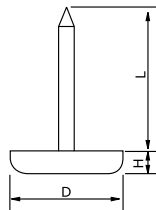

Part No.	Size				Colour
	D	H	L	C	
120070	3/4"	1/5"	5/8"	1.9mm	Brown/Natural
120071	7/8"	1/5"	5/8"	1.9mm	Brown/Natural

Part No.	Size				Colour
	D	H	L	C	
120130	19mm	10mm	25mm	1.9mm	Nickel
120131	22mm	10mm	25mm	1.9mm	Nickel
120132	24mm	10mm	25mm	1.9mm	Nickel
120133	27mm	10mm	25mm	1.9mm	Nickel

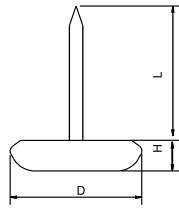

Part No.	Size			Colour
	D	L	C	
120140	19mm	25mm	1.9mm	Nickel
120141	22mm	25mm	1.9mm	Nickel
120142	24mm	25mm	1.9mm	Nickel
120143	27mm	25mm	1.9mm	Nickel

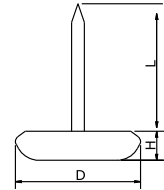

Part No.	Size			Colour
	D	H	L	
120180	20mm	4mm	14mm	Nickel
120181	22mm	4mm	14mm	Nickel
120182	24mm	4mm	14mm	Nickel
120183	28mm	4mm	14mm	Nickel

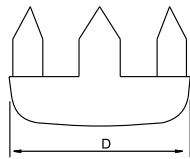

Part No.	Size		Colour
	D		
120210	15mm		Nickel
120211	18mm		Nickel
120212	21mm		Nickel
120213	24mm		Nickel



Part No.	Size			Colour
	D	H	L	
120170	19mm	10mm	25mm	Nickel
120171	22mm	10mm	25mm	Nickel
120172	24mm	10mm	25mm	Nickel
120173	28mm	10mm	25mm	Nickel



Part No.	Size		Colour
	D		
120150	13mm		Rubber
120151	19mm		Rubber
120152	22mm		Rubber
120153	25mm		Rubber
120154	28mm		Rubber



FELT GLIDES





FELT GLIDES SERIES

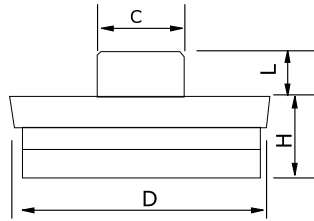

Part No.	Dia.	H	Colour	Material
140015	28mm	16mm	Black and grey	Nylon/Felt

Part No.	D	H	L	C	Colour	Material
140033	4/3"	9mm	4mm	9mm	Br/Wh	ABS and Felt
140030	7/8"	9mm	4mm	9mm	Br/Wh	ABS and Felt
140031	1"	9mm	4mm	9mm	Br/Wh	ABS and Felt
140032	1-1/2"	9mm	4mm	9mm	Br/Wh	ABS and Felt



Part No.	Dia.	H	Colour	Material
140016	32mm	22mm	Wh and Gr	Nylon/Felt



Part No.	Dia.	H	Colour	Material
140017	32mm	22mm	Wh and Gr	Nylon/Felt



Part No.	Dia.	H	Colour	Material
140050	1-3/8"	8.5mm	Ch/Wh	Nylon/Felt
140051	1-3/8"	11mm	Ch/Wh	Nylon/Felt



Part No.	Dia.	H	Colour	Material
140070	25mm	9mm	Brown and Grey	TPR and Felt
140071	30mm	9mm	Brown and Grey	TPR and Felt
140072	40mm	9mm	Brown and Grey	TPR and Felt
140073	50mm	9mm	Brown and Grey	TPR and Felt
140074	60mm	9mm	Brown and Grey	TPR and Felt
140075	70mm	9mm	Brown and Grey	TPR and Felt
140076	35x35mm	9mm	Brown and Grey	TPR and Felt
140077	55x55mm	9mm	Brown and Grey	TPR and Felt
140078	25x100mm	9mm	Brown and Grey	TPR and Felt



Part No.	Dia.	H	Colour	Material
140060	1-1/4"	15mm	Ch/Br/Wh	Nylon/Felt
140061	1-3/8"	15mm	Ch/Br/Wh	Nylon/Felt

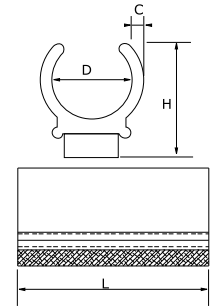
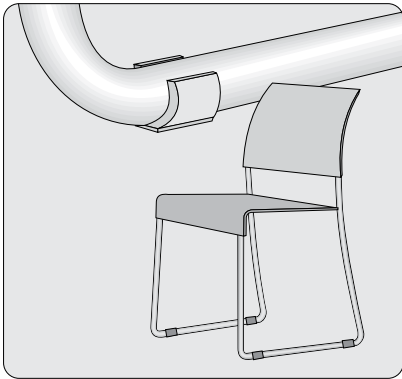

Part No.	D	H	L	C	Colour	Material
140013	1/2"(12.7mm)	22mm	45mm	3mm	Clear	ABS and Felt
140012	5/8"(16mm)	23mm	50mm	3mm	Clear	ABS and Felt
140011	3/4"(19mm)	24mm	50mm	3mm	Clear	ABS and Felt
140010	1-1/8"(28.6mm)	30mm	15mm	3mm	Clear	ABS and Felt



Part No.	Size	Colour	Material
140040	7/8"	Br/Wh	HDPE and Felt



Part No.	Base dia.	H	Stem thread	Colour	Material
140020	1"	1 1/25"	1/4"-20Sx1"	Brown and Grey	HDPE and Felt
140021	1"	1 1/25"	5/16"-18Sx1"	Brown and Grey	HDPE and Felt



Part No.	Dia.	H	Colour	Material
140014	13mm		Black and grey	Nylon/Felt



Part No.	Base dia.	H	Stem thread	Colour	Material
140080	18mm	9mm	1/4"-20Sx1"	White and Grey	HDPE and Felt
140081	18mm	9mm	5/16"-18Sx1"	White and Grey	HDPE and Felt

CAPS





CAPS



Part No.	Dia.	H	Colour	Material
150010	1/2"	1.18"	White/Black/Grey	PVC
150011	5/8"	1.26"	White/Black/Grey	PVC
150012	3/4"	1.26"	White/Black/Grey	PVC
150013	7/8"	1.28"	White/Black/Grey	PVC
150014	1"	1.42"	White/Black/Grey	PVC
150015	1-1/8"	1.57"	White/Black/Grey	PVC
150016	1-1/4"	1.57"	White/Black/Grey	PVC



Part No.	Dia.	H	Colour	Material
150020	1/2"	1.06"	White/Black	TPR
150021	5/8"	1.18"	White/Black	TPR
150022	3/4"	1.18"	White/Black	TPR
150023	7/8"	1.38"	White/Black	TPR
150024	1"	1.57"	White/Black	TPR
150025	1-1/8"	1.57"	White/Black	TPR
150026	1-1/4"	1.57"	White/Black	TPR



Part No.	Dia.	H	Colour	Material
150070	12mm	19mm	White/Black	TPR
150071	16mm	19mm	White/Black	TPR
150072	18mm	19mm	White/Black	TPR
150073	20mm	19mm	White/Black	TPR
150074	22mm	19mm	White/Black	TPR
150075	25mm	19mm	White/Black	TPR
150076	28mm	19mm	White/Black	TPR



Part No.	Dia.	H	Colour	Material
150080	1/2"	1.79"	White/Black/Grey	PP
150081	5/8"	1.79"	White/Black/Grey	PP
150082	3/4"	1.79"	White/Black/Grey	PP
150083	7/8"	1.79"	White/Black/Grey	PP
150084	1"	1.79"	White/Black/Grey	PP
150085	1-1/8"	1.79"	White/Black/Grey	PP
150086	1-1/4"	1.79"	White/Black/Grey	PP



Part No.	Dia.	H	Colour	Material
150040	1/2"	1.79"	White/Black/Grey	PP
150041	5/8"	1.79"	White/Black/Grey	PP
150042	3/4"	1.79"	White/Black/Grey	PP
150043	7/8"	1.79"	White/Black/Grey	PP
150044	1"	1.79"	White/Black/Grey	PP
150045	1-1/8"	1.79"	White/Black/Grey	PP
150046	1-1/4"	1.79"	White/Black/Grey	PP



Part No.	Dia.	H	Colour	Material
150030	1/2"	1.06"	White/Black	TPR
150031	5/8"	1.18"	White/Black	TPR
150032	3/4"	1.18"	White/Black	TPR
150033	7/8"	1.38"	White/Black	TPR
150034	1"	1.57"	White/Black	TPR
150035	1-1/8"	1.57"	White/Black	TPR
150036	1-1/4"	1.57"	White/Black	TPR



Part No.	Dia.	H	Colour	Material
150090	12mm	19mm	Clear	TPR+Felt
150091	16mm	22mm	Clear	TPR+Felt
150092	18mm	24mm	Clear	TPR+Felt
150093	20mm	26mm	Clear	TPR+Felt
150094	22mm	27mm	Clear	TPR+Felt
150095	25mm	30mm	Clear	TPR+Felt
150096	28mm	32mm	Clear	TPR+Felt



Part No.	Dia.	H	Colour	Material
150050	3/4"-7/8"	1.65"	Brown	Rubber

FLOOR PROTECTORS



FLOOR PROTECTORS SERIES

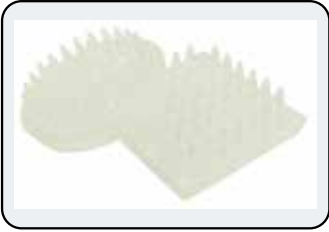

Part No.	Dia.	Colour	Material
160010	1-1/2"(38mm) Round	Clear	PVC
160011	2"(51mm) Round	Clear	PVC
160012	2-1/4"(57mm) Square	Clear	PVC



Part No.	Dia.	Colour	Material
160020	1-1/2"(38mm) Round	Clear	PVC
160021	2"(51mm) Round	Clear	PVC
160022	2-1/4"(57mm) Square	Clear	PVC

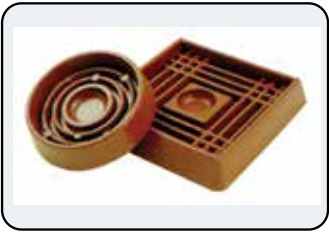

Part No.	Dia.	Colour	Material
160030	1-1/2"(38mm) Round	Brown	PVC
160031	2-1/4"(57mm) Round	Brown	PVC
160032	2"(51mm) Square	Brown	PVC
160033	2-1/2"(64mm) Square	Brown	PVC



Part No.	Dia.	Colour	Material
160040	1-3/4"(45mm) Round	Brown	Felt and Steel
160041	2-1/4"(57mm) Round	Brown	Felt and Steel
160042	2-3/8"(60mm) Square	Brown	Felt and Steel
160043	3"(76mm) Square	Brown	Felt and Steel



SWIVEL GLIDES





SWIVEL GLIDES

Swivel Glide Base Options

Base Material	Picture	Application	Friction Coefficient
Nylon		Carpet Wood Floor	0.15-0.25
Steel		Carpet Outdoor	0.22-0.35
Plastic Alloy		Carpet Wood Floor Outdoor	0.10
PTFE Teflon		Carpet Wood Floor	0.09
Anti-Skid Plastic		Wood Floor Stone Floor Ceramic Floor	0.15-0.25



**Find anything interesting?
Need something you can't find?**



Give us a call at:
(416) 798.7887
1 (800) 849.4011





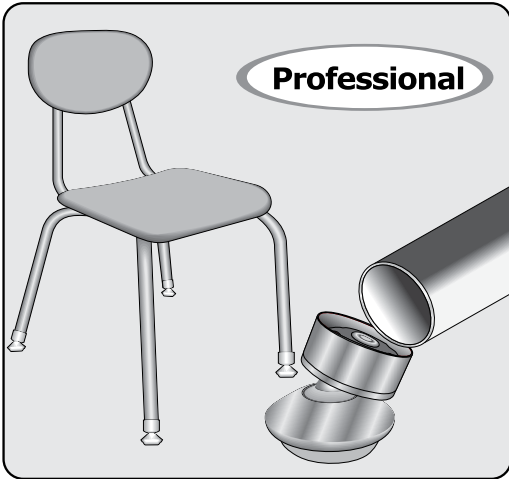

Or email us at:
sales@fcimoldedproducts.com

We would be more than happy to assist!

SWIVEL GLIDES SERIES



Base Options

Part No.	Tube O.D.	Tube	Metal Surface
100030	5/8"	16/18GA	Nickel Plated
100031	3/4"	16/18GA	Nickel Plated
100032	7/8"	16/18GA	Nickel Plated
100033	1"	16/18GA	Nickel Plated
100034	1-1/8"	16/18GA	Nickel Plated



Base Options

Part No.	Tube O.D.	Tube	Metal Surface
100050	3/4"	16/18GA	Nickel Plated
100051	7/8"	16/18GA	Nickel Plated
100052	1"	16/18GA	Nickel Plated
100053	1-1/8"	16/18GA	Nickel Plated

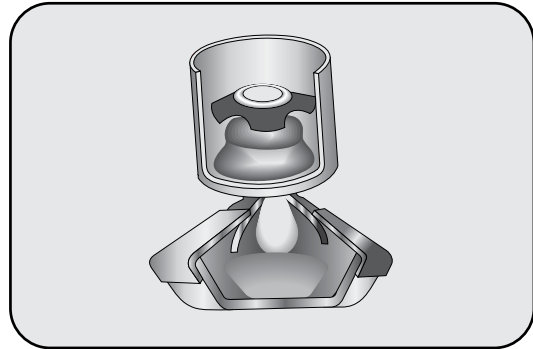

Base Options

Part No.	Tube O.D.	Tube	Metal Surface
100010	5/8"	16/18GA	Nickel Plated



Base Options

Part No.	Tube O.D.	Tube	Metal Surface
100020	5/8"	16/18GA	Nickel Plated



Base Options

Part No.	Tube O.D.	Tube	Metal Surface
100040	3/4"	16/18GA	Nickel Plated



Part No.	Tube O.D.	Tube	Metal Surface
100190	5/8"	16/18GA	Nickel Plated
100191	3/4"	16/18GA	Nickel Plated
100192	7/8"	16/18GA	Nickel Plated
100193	1"	16/18GA	Nickel Plated
100194	1-1/8"	16/18GA	Nickel Plated



Part No.	Tube O.D.	Tube	Metal Surface
100070	5/8"x5/8"	16/18GA	Nickel Plated
100071	3/4"x3/4"	16/18GA	Nickel Plated
100072	7/8"x7/8"	16/18GA	Nickel Plated
100073	1"x1"	16/18GA	Nickel Plated
100074	1-1/8"x1-1/8"	16/18GA	Nickel Plated

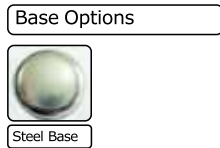

Part No.	Tube O.D.	Tube	Metal Surface
100180	5/8"	16/18GA	Nickel Plated
100181	3/4"	16/18GA	Nickel Plated
100182	7/8"	16/18GA	Nickel Plated
100183	1"	16/18GA	Nickel Plated
100184	1-1/8"	16/18GA	Nickel Plated

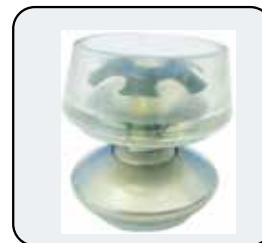

Part No.	Tube O.D.	Tube	Metal Surface
100160	1"	16/18GA	Nickel Plated
100161	1-1/8"	16/18GA	Nickel Plated



Part No.	Tube O.D.	Tube	Metal Surface
100060	5/8"	16/18GA	Nickel Plated
100061	3/4"	16/18GA	Nickel Plated
100062	7/8"	16/18GA	Nickel Plated
100063	1"	16/18GA	Nickel Plated
100064	1-1/8"	16/18GA	Nickel Plated



SWIVEL GLIDES SERIES

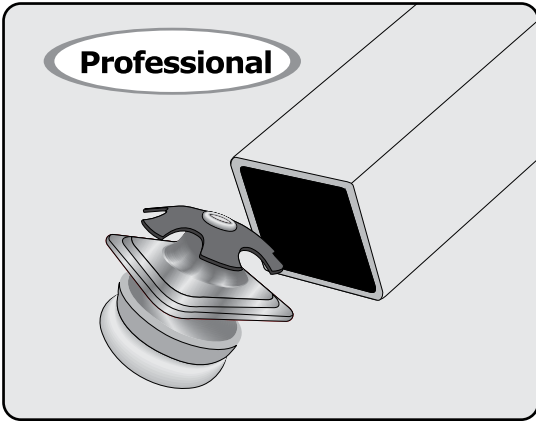

Base Diameter: 24mm 26mm 28mm 30mm 32mm

Part No.	Tube O.D.	Tube	Metal Surface
100130	7/8"x7/8"	16/18GA	Nickel Plated
100131	1"x1"	16/18GA	Nickel Plated
100132	1-1/4"x1-1/4"	16/18GA	Nickel Plated



Base Diameter: 24mm 26mm 28mm 30mm 32mm

Part No.	Tube O.D.	Tube	Metal Surface
100140	7/8"x7/8"	16/18GA	Nickel Plated
100141	1"x1"	16/18GA	Nickel Plated

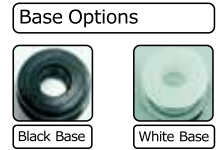

Part No.	Tube O.D.	Tube	Metal Surface
100200	7/8"x7/8"	16/18GA	Nylon
100201	1"x1"	16/18GA	Nylon



Base Diameter: 24mm 26mm 28mm 30mm 32mm

Part No.	Tube O.D.	Tube	Metal Surface
100120	5/8"x5/8"	16/18GA	Nickel Plated
100121	3/4"x3/4"	16/18GA	Nickel Plated
100122	7/8"x7/8"	16/18GA	Nickel Plated
100123	1"x1"	16/18GA	Nickel Plated
100124	1-1/8"x1-1/8"	16/18GA	Nickel Plated



Part No.	Tube O.D.	Tube	Metal Surface
100170	7/8"	16/18GA	Nylon
100171	1"	16/18GA	Nylon



Base Options



Base Diameter: 24mm 26mm 28mm 30mm 32mm

Part No.	Tube O.D.	Tube	Metal Surface
100150	0.71"	16/18GA	Nickel Plated



Base Options



Base Diameter: 24mm 26mm 28mm 30mm 32mm

Part No.	Tube O.D.	Tube	Metal Surface
100080	1-1/4"	16/18GA	Nickel Plated



Base Options

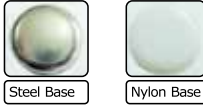

Base Diameter: 24mm 26mm 28mm 30mm 32mm

Part No.	Tube O.D.	Tube	Metal Surface
100110	3/4"	16/18GA	Nickel Plated
100111	7/8"	16/18GA	Nickel Plated
100112	1"	16/18GA	Nickel Plated
100113	1-1/8"	16/18GA	Nickel Plated



Base Options



Base Diameter: 24mm 26mm 28mm 30mm 32mm

Part No.	Tube O.D.	Tube	Metal Surface
100210	3/4"	16/18GA	Nickel Plated



Base Options



Base Diameter: 24mm 26mm 28mm 30mm 32mm

Part No.	Tube O.D.	Tube	Metal Surface
100220	5/8"	16/18GA	Nickel Plated
100221	3/4"	16/18GA	Nickel Plated



Base Options



Base Diameter: 24mm 26mm 28mm 30mm 32mm

Part No.	Tube O.D.	Tube	Metal Surface
100090	7/8"	16/18GA	Nylon
100091	1"	16/18GA	Nylon



Base Options



Base Diameter: 24mm 26mm 28mm 30mm 32mm

Part No.	Tube O.D.	Tube	Metal Surface
100100	11/20"	16/18GA	PP, Nylon
100101	1"	16/18GA	PP, Nylon









FCI LEVELER INNOVATION

FCI's innovative manufacturing techniques utilize a variety of non-traditional materials. Our Levelers:

- a) Allow furniture to slide smoothly on multiple flooring surfaces
- b) Prevents scratching of wood flooring
- c) Remains durable in very low temperature environments

Our innovative manufacturing techniques utilize a variety of non-traditional materials.

Base Material	Example	Features
PTFE (Teflon)		Easily slides over most surfaces. Very low friction co-efficient. Corrosion and temperature resistant.
Plastic Alloy		An Engineered plastic designed to slide over most surfaces. It is durable and wear resistant.
UHMWPE		Similar to Teflon glides but more affordable.
Injection Felt		Felt base is co-molded to plastic base to protect hardwood and laminate flooring.
Low Temperature Resistant Nylon		Durable, wear resistant nylon base. All purpose and long lasting for all applications.
TPV – Non-slip		Non-slip “TPV” base for all applications requiring non-slip. This material is environmentally friendly and operates well between -60°C to 135°C

INTRODUCING OUR BASE-SWITCHABLE LEVELER



FCI's Base Switchable Leveler offers four major base options:

- 1) Metal Base: for stone and cement surfaces
- 2) Teflon Base: for carpet and wood surfaces
- 3) Felt Base: for wood and ceramic surfaces
- 4) Nylon Base: for wood, ceramic and carpet surfaces

The base can be installed on the upper portion (threaded stud + plastic cover) in seconds. Using this method, we can build and ship our Levelers efficiently according to our customers' needs. Additionally, if our customer purchases bases and upper parts from us, they can customize their own Levelers to suit the needs of their clients.

Base dia.	Stem thread	Stem Length		
25.4mm	1/4"-20S	1"	1.5"	
	5/16"-18S	1"	1.5"	2"
	3/8"-16S	1"	1.5"	2"
	M6	25mm	38mm	50mm
	M8	25mm	38mm	50mm
	M10	25mm	38mm	50mm

Base dia.	Stem thread	Stem Length		
35mm	1/4"-20S	1"	1.5"	
	5/16"-18S	1"	1.5"	2"
	3/8"-16S	1"	1.5"	2"
	M6	25mm	38mm	50mm
	M8	25mm	38mm	50mm
	M10	25mm	38mm	50mm

LEVELER SERIES

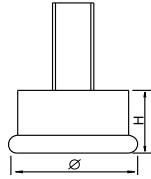

Part No.	Base dia.	H	Stem thread	Colour	Material
110010	7/8"	10.6mm	M7x14.8mm	Black	Nylon/HDPE

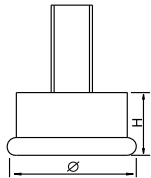

Part No.	Base dia.	H	Stem thread	Colour	Material
110020	7/8"	2/5"	1/4"-20Sx0.5315"	Black	Nylon/HDPE
110021	7/8"	2/5"	M6x13.5mm	Black	Nylon/HDPE

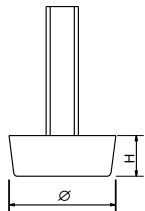

Part No.	Base dia.	H	Stem thread	Colour	Material
110030	7/8"	1/4"	1/4"-20Sx1"	Black/Natural	Nylon/HDPE
110031	7/8"	3/8"	1/4"-20Sx1.5"	Black/Natural	Nylon/HDPE

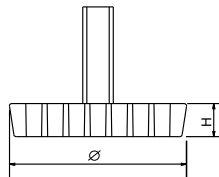

Part No.	Base dia.	H	Stem thread	Colour	Material
110040	7/8"	1/4"	1/4"-20Sx0.75"	Grey/Black	Nylon/HDPE
110041	7/8"	1/4"	5/16"-18Sx1"	Grey/Black	Nylon/HDPE

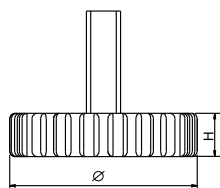

Part No.	Base dia.	H	Stem thread	Colour	Material
110050	1-3/8"	1/4"	1/4"-20Sx0.75"	Grey/Black	Nylon/HDPE
110051	1-3/8"	1/4"	1/4"-20Sx1"	Grey/Black	Nylon/HDPE
110052	1-3/8"	1/4"	5/16"-18Sx1.181"	Grey/Black	Nylon/HDPE
110053	1-3/8"	1/4"	5/16"-18Sx1.732"	Grey/Black	Nylon/HDPE

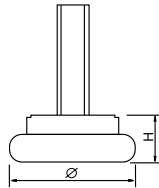

Part No.	Base dia.	H	Stem thread	Colour	Material
110060	1"	3/8"	1/4"-20Sx0.875"	Natural/Black	Nylon/HDPE
110061	1"	3/8"	1/4"-20Sx1"	Natural/Black	Nylon/HDPE
110062	1"	3/8"	1/4"-20Sx1.5"	Natural/Black	Nylon/HDPE
110063	1"	3/8"	5/16"-18Sx0.875"	Natural/Black	Nylon/HDPE
110064	1"	3/8"	5/16"-18Sx1"	Natural/Black	Nylon/HDPE
110065	1"	3/8"	5/16"-18Sx1.5"	Natural/Black	Nylon/HDPE
110067	1"	3/8"	1/4"-20Sx1.732"	Natural/Black	Nylon/HDPE

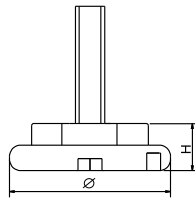

Part No.	Base dia.	H	Stem thread	Colour	Material
110070	1"	3/8"	5/16"-18Sx1"	Natural/Black	Nylon/HDPE
110071	1"	3/8"	5/16"-18Sx1.5"	Natural/Black	Nylon/HDPE
110072	1"	3/8"	3/8"-16Sx1.5"	Natural/Black	Nylon/HDPE
110073	1"	3/8"	3/8"-16Sx2"	Natural/Black	Nylon/HDPE
110080	1-3/8"	2/5"	5/16"-18Sx1"	Natural/Black	Nylon/HDPE
110081	1-3/8"	2/5"	5/16"-18Sx1.5"	Natural/Black	Nylon/HDPE
110082	1-3/8"	2/5"	3/8"-16Sx1.5"	Natural/Black	Nylon/HDPE
110083	1-3/8"	2/5"	3/8"-16Sx2"	Natural/Black	Nylon/HDPE
110084	1-3/8"	2/5"	1/4"-20Sx1"	Natural/Black	Nylon/HDPE

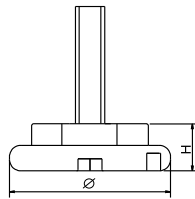

Part No.	Base dia.	H	Stem thread	Colour	Material
110090	1"	3/8"	1/4"-20Sx1"	Natural/Black	Nylon/HDPE
110091	1"	3/8"	1/4"-20Sx1.5"	Natural/Black	Nylon/HDPE
110092	1"	3/8"	5/16"-18Sx1"	Natural/Black	Nylon/HDPE
110093	1"	3/8"	5/16"-18Sx1.5"	Natural/Black	Nylon/HDPE

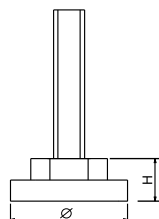

Part No.	Base dia.	H	Stem thread	Colour	Material
110100	1-3/10"	2/5"	1/4"-20Sx1.5"	Natural/Black	Nylon/HDPE
110101	1-3/10"	2/5"	5/16"-18Sx1.5"	Natural/Black	Nylon/HDPE
110102	1-3/10"	2/5"	3/8"-16Sx1.5"	Natural/Black	Nylon/HDPE

LEVELER SERIES

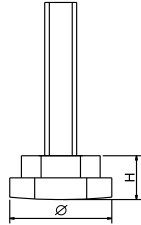

Part No.	Base dia.	H	Stem thread	Colour	Material
110110	1"	3/8"	5/16"-18Sx1"	Natural/Black	Nylon/HDPE
110111	1"	3/8"	5/16"-18Sx1.5"	Natural/Black	Nylon/HDPE
110112	1"	3/8"	5/16"-18Sx2"	Natural/Black	Nylon/HDPE

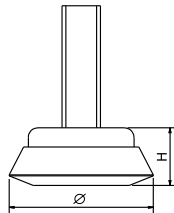

Part No.	Base dia.	H	Stem thread	Colour	Material
110120	1.14"	1/2"	1/4"-20Sx0.787"	Natural/Black	Nylon/HDPE
110121	1.14"	1/2"	1/4"-20Sx1.5"	Natural/Black	Nylon/HDPE
110122	1.14"	1/2"	M6x20mm	Natural/Black	Nylon/HDPE
110123	1.14"	1/2"	M6x38mm	Natural/Black	Nylon/HDPE

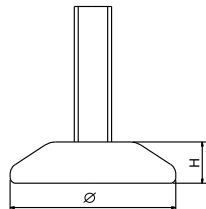

Part No.	Base dia.	H	Stem thread	Colour	Material
110130	1-5/8"	7/16"	5/16"-18Sx1"	Natural/Black	Nylon/HDPE
110131	1-5/8"	7/16"	5/16"-18Sx1.5"	Natural/Black	Nylon/HDPE
110132	1-5/8"	7/16"	3/8"-16Sx1"	Natural/Black	Nylon/HDPE
110133	1-5/8"	7/16"	3/8"-16Sx1.5"	Natural/Black	Nylon/HDPE
110134	28mm	7/16"	1/4"-20Sx7/8"	Natural/Black	Nylon/HDPE
110135	28mm	7/16"	1/4"-20Sx1"	Natural/Black	Nylon/HDPE
110136	28mm	7/16"	5/16"-18Sx7/8"	Natural/Black	Nylon/HDPE
110137	28mm	7/16"	5/16"-18Sx1"	Natural/Black	Nylon/HDPE

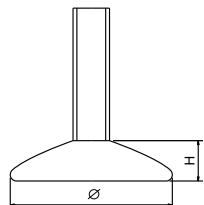

Part No.	Base dia.	H	Stem thread	Colour	Material
110140	1-1/2"	19/64"	5/16"-18Sx1"	Natural/Black	Nylon/HDPE
110141	1-1/2"	19/64"	5/16"-18Sx1.5"	Natural/Black	Nylon/HDPE
110142	1-1/2"	19/64"	3/8"-16Sx1"	Natural/Black	Nylon/HDPE
110143	1-1/2"	19/64"	3/8"-16Sx1.5"	Natural/Black	Nylon/HDPE

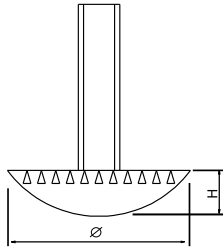

Part No.	Base dia.	H	Stem thread	Colour	Material
110150	3/4"	1/4"	1/4"-20Sx1"	Brown/Black	Nylon/HDPE
110151	3/4"	1/4"	1/4"-20Sx1.5"	Brown/Black	Nylon/HDPE
110152	3/4"	1/4"	1/4"-20Sx2"	Brown/Black	Nylon/HDPE
110153	3/4"	1/4"	M6x25mm	Brown/Black	Nylon/HDPE
110154	3/4"	1/4"	M6x38.1mm	Brown/Black	Nylon/HDPE
110155	3/4"	1/4"	M6x50.8mm	Brown/Black	Nylon/HDPE
110160	7/8"	1/4"	1/4"-20Sx1"	Brown/Black	Nylon/HDPE
110161	7/8"	1/4"	1/4"-20Sx1.5"	Brown/Black	Nylon/HDPE
110162	7/8"	1/4"	1/4"-20Sx2"	Brown/Black	Nylon/HDPE
110163	7/8"	1/4"	M6x25mm	Brown/Black	Nylon/HDPE
110164	7/8"	1/4"	M6x38.1mm	Brown/Black	Nylon/HDPE
110165	7/8"	1/4"	M6x50.8mm	Brown/Black	Nylon/HDPE
110170	1"	1/4"	1/4"-20Sx1"	Brown/Black	Nylon/HDPE
110171	1"	1/4"	1/4"-20Sx1.5"	Brown/Black	Nylon/HDPE
110172	1"	1/4"	1/4"-20Sx2"	Brown/Black	Nylon/HDPE
110173	1"	1/4"	M6x25mm	Brown/Black	Nylon/HDPE
110174	1"	1/4"	M6x38.1mm	Brown/Black	Nylon/HDPE
110175	1"	1/4"	M6x50.8mm	Brown/Black	Nylon/HDPE
110180	1-1/8"	1/4"	1/4"-20Sx1"	Brown/Black	Nylon/HDPE
110181	1-1/8"	1/4"	1/4"-20Sx1.5"	Brown/Black	Nylon/HDPE
110182	1-1/8"	1/4"	1/4"-20Sx2"	Brown/Black	Nylon/HDPE
110183	1-1/8"	1/4"	M6x25mm	Brown/Black	Nylon/HDPE
110184	1-1/8"	1/4"	M6x38.1mm	Brown/Black	Nylon/HDPE
110185	1-1/8"	1/4"	M6x50.8mm	Brown/Black	Nylon/HDPE



Part No.	Base dia.	H	Stem thread	Colour	Material
110750	1-1/4"	0.4"	3/8"-16Sx1"	Black	TPR
110751	1-1/4"	0.4"	3/8"-16Sx1.5"	Black	TPR
110752	1-1/4"	0.4"	3/8"-16Sx2"	Black	TPR
110753	1-1/4"	0.4"	5/16"-18Sx3/4"	Black	TPR

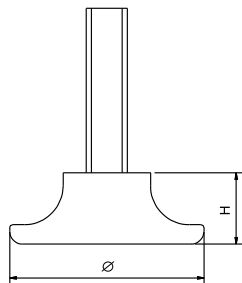

Part No.	Base dia.	H	Stem thread	Colour	Material
110190	1-1/8"	0.455"	M6x50.8mm	Clear	PC

LEVELER SERIES

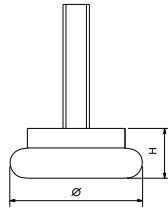

Part No.	Base dia.	H	Stem thread	Colour	Material
110210	19mm	0.394"	1/4"-20Sx0.25"	Nickel plated	Steel and HDPE
110211	19mm	0.394"	1/4"-20Sx1"	Nickel plated	Steel and HDPE
110220	22mm	0.394"	1/4"-20Sx0.25"	Nickel plated	Steel and HDPE
110221	22mm	0.394"	1/4"-20Sx1"	Nickel plated	Steel and HDPE
110230	24mm	0.394"	1/4"-20Sx0.25"	Nickel plated	Steel and HDPE
110231	24mm	0.394"	1/4"-20Sx1"	Nickel plated	Steel and HDPE
110232	24mm	0.394"	1/4"-20Sx1.5"	Nickel plated	Steel and HDPE
110233	24mm	0.394"	5/16"-18Sx1"	Nickel plated	Steel and HDPE
110234	24mm	0.394"	5/16"-18Sx1.5"	Nickel plated	Steel and HDPE
110240	27mm	0.394"	1/4"-20Sx0.25"	Nickel plated	Steel and HDPE
110241	27mm	0.394"	1/4"-20Sx1"	Nickel plated	Steel and HDPE
110242	27mm	0.394"	1/4"-20Sx1.5"	Nickel plated	Steel and HDPE
110243	27mm	0.394"	5/16"-18Sx1"	Nickel plated	Steel and HDPE
110244	27mm	0.394"	5/16"-18Sx1.5"	Nickel plated	Steel and HDPE
110250	30mm	0.394"	1/4"-20Sx0.25"	Nickel plated	Steel and HDPE
110251	30mm	0.394"	1/4"-20Sx1"	Nickel plated	Steel and HDPE
110252	30mm	0.394"	1/4"-20Sx1.5"	Nickel plated	Steel and HDPE
110253	30mm	0.394"	5/16"-18Sx1"	Nickel plated	Steel and HDPE
110254	30mm	0.394"	5/16"-18Sx1.5"	Nickel plated	Steel and HDPE

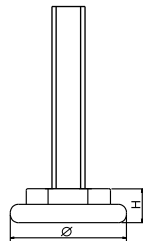

Part No.	Base dia.	H	Stem thread	Colour	Material
110270	27mm	2/5"	1/4"-20Sx1"	Nickel plated	Steel and HDPE
110271	27mm	2/5"	1/4"-20Sx1.5"	Nickel plated	Steel and HDPE
110272	27mm	2/5"	5/16"-18Sx1"	Nickel plated	Steel and HDPE
110273	27mm	2/5"	5/16"-18Sx1.5"	Nickel plated	Steel and HDPE

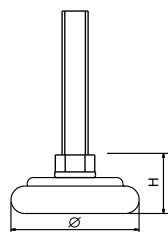

Part No.	Base dia.	H	Stem thread	Colour	Material
110280	1-1/4"	0.58"	5/16"-18Sx1"	Zinc plated	Steel and Nylon
110281	1-1/4"	0.58"	5/16"-18Sx1.5"	Zinc plated	Steel and Nylon
110282	1-1/4"	0.58"	5/16"-18Sx2"	Zinc plated	Steel and Nylon
110283	1-1/4"	0.58"	3/8"-16Sx1"	Zinc plated	Steel and Nylon
110284	1-1/4"	0.58"	3/8"-16Sx1.5"	Zinc plated	Steel and Nylon
110285	1-1/4"	0.58"	3/8"-16Sx2"	Zinc plated	Steel and Nylon



Part No.	Base dia.	H	Stem thread	Colour	Material
110790	0.71"	1/4"	3/8"-16Sx1"	Black	Nylon/HDPE
110791	0.71"	1/4"	3/8"-16Sx1.5"	Black	Nylon/HDPE



Part No.	Base dia.	H	Stem thread	Colour	Material
110810	2-1/2"	11/16"	3/8"-16Sx1.1"	Black	Nylon
110811	2-1/2"	11/16"	3/8"-16Sx1.424"	Black	Nylon
110812	2-1/2"	11/16"	3/8"-16Sx1.85"	Black	Nylon
110813	2-1/2"	11/16"	3/8"-16Sx3.39"	Black	Nylon



Part No.	Base dia.	H	Stem thread	Colour	Material
110820	2.28"	4/5"	3/8"-16Sx1"	Grey/Black	Nylon
110821	2.28"	4/5"	3/8"-16Sx1.5"	Grey/Black	Nylon
110822	2.28"	4/5"	3/8"-16Sx2"	Grey/Black	Nylon
110823	2.28"	4/5"	3/8"-16Sx3"	Grey/Black	Nylon



Part No.	Base dia.	H	Stem thread	Colour	Material
110260	1.85"	1"	3/8"-16Sx3"	Brown	Nylon
110261	1.85"	1"	3/8"-16Sx3.5"	Brown	Nylon

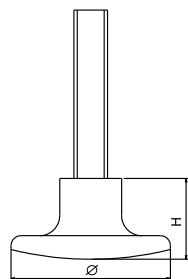

LEVELER SERIES

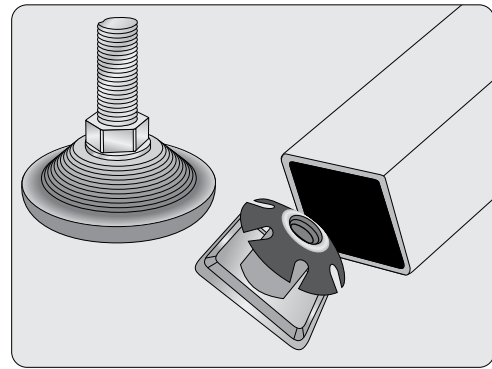
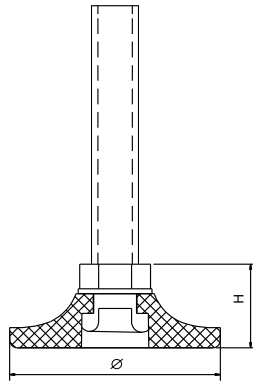
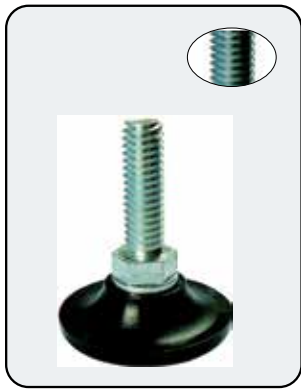

Part No.	Base dia.	H	Stem thread	Length of stem thread			Colour	Material
110310	25.4mm	0.56"	1/4"-20S	1"	1.5"	2"	Natural/Black	Nylon/HDPE
110311		0.638"	5/16"-18S	1"	1.5"	2"	Natural/Black	Nylon/HDPE
110312		14.2mm	M6	25mm	38mm	50mm	Natural/Black	Nylon/HDPE
110313		16.2mm	M8	25mm	38mm	50mm	Natural/Black	Nylon/HDPE
110314	28.5mm	0.49"	1/4"-20S	1"	1.5"	2"	Natural/Black	Nylon/HDPE
110315		0.57"	5/16"-18S	1"	1.5"	2"	Natural/Black	Nylon/HDPE
110316		12.5mm	M6	25mm	38mm	50mm	Natural/Black	Nylon/HDPE
110317		14.5mm	M8	25mm	38mm	50mm	Natural/Black	Nylon/HDPE
110318	32mm	0.57"	1/4"-20S	1"	1.5"	2"	Natural/Black	Nylon/HDPE
110319		0.65"	5/16"-18S	1"	1.5"	2"	Natural/Black	Nylon/HDPE
110320		0.65"	3/8"-16S	1"	1.5"	2"	Natural/Black	Nylon/HDPE
110321		14.5mm	M6	25mm	38mm	50mm	Natural/Black	Nylon/HDPE
110322		16.5mm	M8	25mm	38mm	50mm	Natural/Black	Nylon/HDPE
110323		16.5mm	M10	25mm	38mm	50mm	Natural/Black	Nylon/HDPE
110324	35mm	0.472"	1/4"-20S	1"	1.5"	2"	Natural/Black	Nylon/HDPE
110325		0.472"	5/16"-18S	1"	1.5"	2"	Natural/Black	Nylon/HDPE
110326		0.492"	3/8"-16S	1"	1.5"	2"	Natural/Black	Nylon/HDPE
110327		12mm	M6	25mm	38mm	50mm	Natural/Black	Nylon/HDPE
110328		12mm	M8	25mm	38mm	50mm	Natural/Black	Nylon/HDPE
110329		12.5mm	M10	25mm	38mm	50mm	Natural/Black	Nylon/HDPE
110330	43mm	0.57"	1/4"-20S	1"	1.5"	2"	Natural/Black	Nylon/HDPE
110331		0.65"	5/16"-18S	1"	1.5"	2"	Natural/Black	Nylon/HDPE
110332		0.65"	3/8"-16S	1"	1.5"	2"	Natural/Black	Nylon/HDPE
110333		14.5mm	M6	25mm	38mm	50mm	Natural/Black	Nylon/HDPE
110334		16.5mm	M8	25mm	38mm	50mm	Natural/Black	Nylon/HDPE
110335		16.5mm	M10	25mm	38mm	50mm	Natural/Black	Nylon/HDPE

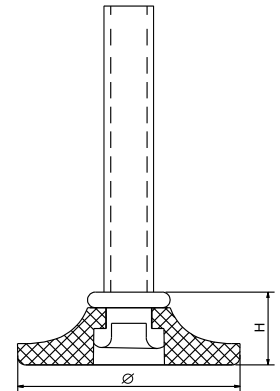

Part No.	Base dia.	H	Stem thread	Length of stem thread			Colour	Material
110350	25.4mm	0.46"	1/4"-20S	1"	1.5"	2"	Natural/Black	Nylon/HDPE
110351		0.46"	5/16"-18S	1"	1.5"	2"	Natural/Black	Nylon/HDPE
110352		11.7mm	M6	25mm	38mm	50mm	Natural/Black	Nylon/HDPE
110353		11.7mm	M8	25mm	38mm	50mm	Natural/Black	Nylon/HDPE
110354	28.5mm	0.393"	1/4"-20S	1"	1.5"	2"	Natural/Black	Nylon/HDPE
110355		0.393"	5/16"-18S	1"	1.5"	2"	Natural/Black	Nylon/HDPE
110356		10mm	M6	25mm	38mm	50mm	Natural/Black	Nylon/HDPE
110357		10mm	M8	25mm	38mm	50mm	Natural/Black	Nylon/HDPE
110358	32mm	0.472"	1/4"-20S	1"	1.5"	2"	Natural/Black	Nylon/HDPE
110359		0.472"	5/16"-18S	1"	1.5"	2"	Natural/Black	Nylon/HDPE
110360		0.492"	3/8"-16S	1"	1.5"	2"	Natural/Black	Nylon/HDPE
110361		12mm	M6	25mm	38mm	50mm	Natural/Black	Nylon/HDPE
110362		12mm	M8	25mm	38mm	50mm	Natural/Black	Nylon/HDPE
110363		12.5mm	M10	25mm	38mm	50mm	Natural/Black	Nylon/HDPE
110364	35mm	0.472"	1/4"-20S	1"	1.5"	2"	Natural/Black	Nylon/HDPE
110365		0.472"	5/16"-18S	1"	1.5"	2"	Natural/Black	Nylon/HDPE
110366		0.492"	3/8"-16S	1"	1.5"	2"	Natural/Black	Nylon/HDPE
110367		12mm	M6	25mm	38mm	50mm	Natural/Black	Nylon/HDPE
110368		12mm	M8	25mm	38mm	50mm	Natural/Black	Nylon/HDPE
110369		12.5mm	M10	25mm	38mm	50mm	Natural/Black	Nylon/HDPE
110370	43mm	0.512"	1/4"-20S	1"	1.5"	2"	Natural/Black	Nylon/HDPE
110371		0.512"	5/16"-18S	1"	1.5"	2"	Natural/Black	Nylon/HDPE
110372		0.531"	3/8"-16S	1"	1.5"	2"	Natural/Black	Nylon/HDPE
110373		13mm	M6	25mm	38mm	50mm	Natural/Black	Nylon/HDPE
110374		13mm	M8	25mm	38mm	50mm	Natural/Black	Nylon/HDPE
110375		13.5mm	M10	25mm	38mm	50mm	Natural/Black	Nylon/HDPE

LEVELER SERIES



Part No.	Base dia.	H	Stem thread	Colour	Material
110980	30mm	14mm	M8x25mm	Black/Grey	Nylon/HDPE
110981	30mm	14mm	5/16"-18Sx1"	Black/Grey	Nylon/HDPE



Part No.	Base dia.	H	Stem thread	Colour	Material
111020	50mm	17mm	M8x25mm	Black/Natural	Nylon/HDPE
111021	50mm	17mm	5/16"-18Sx1"	Black/Natural	Nylon/HDPE



Part No.	Base dia.	H	Stem thread	Colour	Material
110760	1-3/8"	0.7"	5/16"-18Sx1"	Black/Natural	Nylon/HDPE
110761	1-3/8"	0.7"	M8x25mm	Black/Natural	Nylon/HDPE



Part No.	Base dia.	H	Stem thread	Colour	Material
110770	1-11/16"	0.5"	3/8"-16Sx1.5"	Black/Natural	Nylon/HDPE
110771	1-11/16"	0.5"	3/8"-16Sx2"	Black/Natural	Nylon/HDPE



Part No.	Base dia.	H	Stem thread	Colour	Material
110800	2-1/2"	0.5"	5/16"-18Sx1"	Black/Natural	Nylon/HDPE
110801	2-1/2"	0.5"	5/16"-18Sx1.5"	Black/Natural	Nylon/HDPE
110802	2-1/2"	0.5"	5/16"-18Sx2"	Black/Natural	Nylon/HDPE
110803	2-1/2"	0.5"	3/8"-16Sx1"	Black/Natural	Nylon/HDPE
110804	2-1/2"	0.5"	3/8"-16Sx1.5"	Black/Natural	Nylon/HDPE
110805	2-1/2"	0.5"	3/8"-16Sx2"	Black/Natural	Nylon/HDPE

/Black



Part No.	Base dia.	H	Stem thread	Colour	Material
110990	40mm	0.5"	5/16"-18Sx1"	Black/Natural	Nylon/HDPE
110991	40mm	0.5"	5/16"-18Sx1.5"	Black/Natural	Nylon/HDPE
110992	40mm	0.5"	5/16"-18Sx2"	Black/Natural	Nylon/HDPE
110993	40mm	0.5"	3/8"-16Sx1"	Black/Natural	Nylon/HDPE
110994	40mm	0.5"	3/8"-16Sx1.5"	Black/Natural	Nylon/HDPE
110995	40mm	0.5"	3/8"-16Sx2"	Black/Natural	Nylon/HDPE



Part No.	Base dia.	H	Stem thread	Colour	Material
111000	48mm	0.4"	5/16"-18Sx1"	Black/Natural	Nylon/HDPE
111001	48mm	0.4"	5/16"-18Sx1.5"	Black/Natural	Nylon/HDPE
111002	48mm	0.4"	5/16"-18Sx2"	Black/Natural	Nylon/HDPE
111003	48mm	0.4"	3/8"-16Sx1"	Black/Natural	Nylon/HDPE
111004	48mm	0.4"	3/8"-16Sx1.5"	Black/Natural	Nylon/HDPE
111005	48mm	0.4"	3/8"-16Sx2"	Black/Natural	Nylon/HDPE

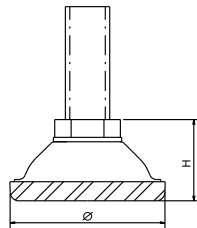

Part No.	Base dia.	H	Stem thread	Colour	Material
110290	1-3/8"	0.7"	3/8"-16Sx1"	Natural	Nylon/HDPE
110291	1-3/8"	0.7"	3/8"-16Sx1.5"	Natural	Nylon/HDPE
110292	1-3/8"	0.7"	3/8"-16Sx2"	Natural	Nylon/HDPE
110293	1-3/8"	0.7"	M10x25mm	Natural	Nylon/HDPE
110294	1-3/8"	0.7"	M10x38.1mm	Natural	Nylon/HDPE
110295	1-3/8"	0.7"	M10x50.8mm	Natural	Nylon/HDPE

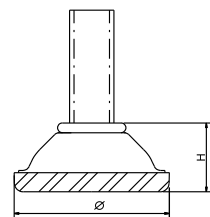

Part No.	Base dia.	H	Stem thread	Colour	Material
110300	1-3/8"	1/2"	3/8"-16Sx1"	Natural	Nylon/HDPE
110301	1-3/8"	1/2"	3/8"-16Sx1.5"	Natural	Nylon/HDPE
110302	1-3/8"	1/2"	3/8"-16Sx2"	Natural	Nylon/HDPE
110303	1-3/8"	1/2"	M10x25mm	Natural	Nylon/HDPE
110304	1-3/8"	1/2"	M10x38.1mm	Natural	Nylon/HDPE
110305	1-3/8"	1/2"	M10x50.8mm	Natural	Nylon/HDPE
110306	1-3/8"	1/2"	5/16"-18Sx1"	Natural	Nylon/HDPE

THREADED METAL ADAPTERS





THREADED METAL ADAPTERS SERIES

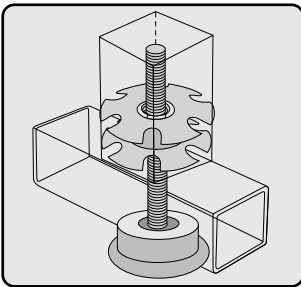

Part No.	Tube O.D.	Stem thread	Tube	Colour	Material
130070	3/4"	1/4"-20S	16/18GA	Zinc plated	Steel
130071	7/8"		16/18GA	Zinc plated	Steel
130072	1"		16/18GA	Zinc plated	Steel
130073	1-1/8"		16/18GA	Zinc plated	Steel
130074	1-1/4"		16/18GA	Zinc plated	Steel
130075	1-1/2"		16/18GA	Zinc plated	Steel
130076	1-3/4"		16/18GA	Zinc plated	Steel
130077	2"		16/18GA	Zinc plated	Steel
130080	7/8"	5/16"-18S	16/18GA	Zinc plated	Steel
130081	1"		16/18GA	Zinc plated	Steel
130082	1-1/8"		16/18GA	Zinc plated	Steel
130083	1-1/4"		16/18GA	Zinc plated	Steel
130084	1-1/2"		16/18GA	Zinc plated	Steel
130085	1-3/4"		16/18GA	Zinc plated	Steel
130086	2"	16/18GA	Zinc plated	Steel	
130090	7/8"	3/8"-16S	16/18GA	Zinc plated	Steel
130091	1"		16/18GA	Zinc plated	Steel
130092	1-1/8"		16/18GA	Zinc plated	Steel
130093	1-1/4"		16/18GA	Zinc plated	Steel
130094	1-1/2"		16/18GA	Zinc plated	Steel
130095	1-3/4"		16/18GA	Zinc plated	Steel
130096	2"		16/18GA	Zinc plated	Steel

Part No.	Tube O.D.	Stem thread	Tube	Colour	Material
130010	5/8"	1/4"-20S	16/18GA	Zinc plated	Steel
130011	3/4"		16/18GA	Zinc plated	Steel
130012	7/8"		16/18GA	Zinc plated	Steel
130013	1"		16/18GA	Zinc plated	Steel
130014	1-1/8"		16/18GA	Zinc plated	Steel
130015	1-1/4"		16/18GA	Zinc plated	Steel
130016	1-1/2"		16/18GA	Zinc plated	Steel
130017	1-3/4"		16/18GA	Zinc plated	Steel
130018	2"	16/18GA	Zinc plated	Steel	
130020	7/8"	5/16"-18S	16/18GA	Zinc plated	Steel
130021	1"		16/18GA	Zinc plated	Steel
130022	1-1/8"		16/18GA	Zinc plated	Steel
130023	1-1/4"		16/18GA	Zinc plated	Steel
130024	1-1/2"		16/18GA	Zinc plated	Steel
130025	1-3/4"		16/18GA	Zinc plated	Steel
130026	2"	16/18GA	Zinc plated	Steel	
130030	7/8"	3/8"-16S	16/18GA	Zinc plated	Steel
130031	1"		16/18GA	Zinc plated	Steel
130032	1-1/8"		16/18GA	Zinc plated	Steel
130033	1-1/4"		16/18GA	Zinc plated	Steel
130034	1-1/2"		16/18GA	Zinc plated	Steel
130035	1-3/4"		16/18GA	Zinc plated	Steel
130036	2"		16/18GA	Zinc plated	Steel

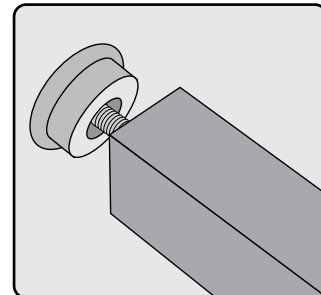



Part No.	Tube O.D.	Stem thread	Tube	Colour	Material
130040	5/8"x5/8"	1/4"-20S	16/18GA	Zinc plated	Steel
130041	3/4"x3/4"		16/18GA	Zinc plated	Steel
130042	7/8"x7/8"		16/18GA	Zinc plated	Steel
130043	1"x1"		16/18GA	Zinc plated	Steel
130044	1-1/8"x1-1/8"		16/18GA	Zinc plated	Steel
130045	1-1/4"x1-1/4"		16/18GA	Zinc plated	Steel
130046	1-1/2"x1-1/2"		16/18GA	Zinc plated	Steel
130047	1-3/4"x1-3/4"		16/18GA	Zinc plated	Steel
130048	2"x2"	16/18GA	Zinc plated	Steel	
130050	7/8"x7/8"	5/16"-18S	16/18GA	Zinc plated	Steel
130051	1"x1"		16/18GA	Zinc plated	Steel
130052	1-1/8"x1-1/8"		16/18GA	Zinc plated	Steel
130053	1-1/4"x1-1/4"		16/18GA	Zinc plated	Steel
130054	1-1/2"x1-1/2"		16/18GA	Zinc plated	Steel
130055	1-3/4"x1-3/4"		16/18GA	Zinc plated	Steel
130056	2"x2"	16/18GA	Zinc plated	Steel	
130060	7/8"x7/8"	3/8"-16S	16/18GA	Zinc plated	Steel
130061	1"x1"		16/18GA	Zinc plated	Steel
130062	1-1/8"x1-1/8"		16/18GA	Zinc plated	Steel
130063	1-1/4"x1-1/4"		16/18GA	Zinc plated	Steel
130064	1-1/2"x1-1/2"		16/18GA	Zinc plated	Steel
130065	1-3/4"x1-3/4"		16/18GA	Zinc plated	Steel
130066	2"x2"		16/18GA	Zinc plated	Steel

Part No.	Tube O.D.	Stem thread	Tube	Colour	Material
130130	1-1/2"x1-1/2"	1/2"-13S	16/18GA	Zinc plated	Steel
130131	1-3/4"x1-3/4"		16/18GA	Zinc plated	Steel
130132	2"x2"		16/18GA	Zinc plated	Steel

Part No.	Tube O.D.	Stem thread	Tube	Colour	Material
130100	7/8"x7/8"	1/4"-20S	16/18GA	Zinc plated	Steel
130101	1"x1"		16/18GA	Zinc plated	Steel
130102	1-1/8"x1-1/8"		16/18GA	Zinc plated	Steel
130110	7/8"x7/8"	5/16"-18S	16/18GA	Zinc plated	Steel
130111	1"x1"		16/18GA	Zinc plated	Steel
130112	1-1/8"x1-1/8"		16/18GA	Zinc plated	Steel
130120	7/8"x7/8"	3/8"-16S	16/18GA	Zinc plated	Steel
130121	1"x1"		16/18GA	Zinc plated	Steel
130122	1-1/8"x1-1/8"		16/18GA	Zinc plated	Steel

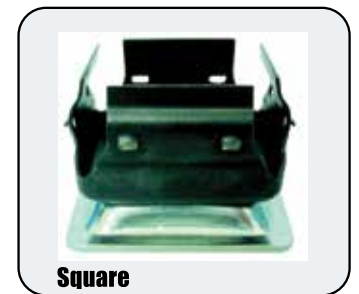

INDUSTRIAL LEVELERS





INDUSTRIAL LEVELERS SERIES



Part No.	Base Diameter	Stem thread	Material
250010	30mm	M10x30mmL	Carbon steel
250011	50mm	M16x50mmL	Carbon steel
250012	80mm	M16x50mmL	Carbon steel
250013	80mm	M16x100mmL	Carbon steel
250014	80mm	M20x75mmL	Carbon steel
250015	100mm	M20x100mmL	Carbon steel



Part No.	Base Diameter	Stem thread	Material
250040	80mm	M16x50mmL	Carbon steel
250041	80mm	M16x100mmL	Carbon steel
250042	80mm	M20x100mmL	Carbon steel
250043	100mm	M16x50mmL	Carbon steel
250044	100mm	M16x100mmL	Carbon steel
250045	100mm	M20x100mmL	Carbon steel
250046	100mm	M20x100mmL	Carbon steel
250047	123mm	M20x100mmL	Carbon steel
250048	123mm	M24x100mmL	Carbon steel



Part No.	Base Diameter	Stem thread	Material
250080	50mm	M8x50mmL	Carbon steel
250081	50mm	M8x100mmL	Carbon steel
250082	50mm	M10x30mmL	Carbon steel
250083	50mm	M10x50mmL	Carbon steel
250084	50mm	M10x100mmL	Carbon steel
250085	50mm	M12x50mmL	Carbon steel
250086	50mm	M12x100mmL	Carbon steel
250087	60mm	M10x100mmL	Carbon steel
250088	60mm	M12x50mmL	Carbon steel
250089	60mm	M12x100mmL	Carbon steel
250090	80mm	M16x50mmL	Carbon steel
250091	80mm	M16x100mmL	Carbon steel
250092	80mm	M20x100mmL	Carbon steel
250093	100mm	M16x50mmL	Carbon steel
250094	100mm	M16x100mmL	Carbon steel
250095	100mm	M20x50mmL	Carbon steel
250096	100mm	M20x100mmL	Carbon steel
250097	123mm	M20x100mmL	Carbon steel
250098	123mm	M24x100mmL	Carbon steel



Part No.	Base Diameter	Stem thread	Material
250050	50mm	M8x50mmL	Carbon steel
250051	50mm	M8x100mmL	Carbon steel
250052	50mm	M10x30mmL	Carbon steel
250053	50mm	M10x50mmL	Carbon steel
250054	50mm	M10x100mmL	Carbon steel
250055	50mm	M12x50mmL	Carbon steel
250056	50mm	M12x100mmL	Carbon steel
250057	60mm	M10x100mmL	Carbon steel
250058	60mm	M12x50mmL	Carbon steel
250059	60mm	M12x100mmL	Carbon steel
250060	80mm	M16x50mmL	Carbon steel
250061	80mm	M16x100mmL	Carbon steel
250062	80mm	M20x100mmL	Carbon steel



Part No.	Base Diameter	Stem thread	Material
250070	80mm	M16x50mmL	Carbon steel
250071	80mm	M16x100mmL	Carbon steel
250072	80mm	M20x100mmL	Carbon steel
250073	100mm	M16x50mmL	Carbon steel
250074	100mm	M16x100mmL	Carbon steel
250075	100mm	M20x50mmL	Carbon steel
250076	100mm	M20x100mmL	Carbon steel
250077	123mm	M20x100mmL	Carbon steel
250078	123mm	M24x100mmL	Carbon steel



Part No.	Base Diameter	Stem thread	Material
250020	50mm	M8x50mmL	Carbon steel
250021	50mm	M8x100mmL	Carbon steel
250022	50mm	M10x30mmL	Carbon steel
250023	50mm	M10x50mmL	Carbon steel
250024	50mm	M10x100mmL	Carbon steel
250025	50mm	M12x50mmL	Carbon steel
250026	50mm	M12x100mmL	Carbon steel
250027	60mm	M10x100L	Carbon steel
250028	60mm	M12x50mmL	Carbon steel
250029	60mm	M12x100mmL	Carbon steel
250030	80mm	M16x50mmL	Carbon steel
250031	80mm	M16x100mmL	Carbon steel
250032	80mm	M20x100mmL	Carbon steel

KNOBS , LEVERS & HANDLES



KNOBS & HANDLES SERIES



Part No.	Size	Stem thread	Colour	Material
200010	55x28x16mm	1/4"-20Sx1"	Brown/Black	Nylon
200011	55x28x16mm	1/4"-20Sx1.5"	Brown/Black	Nylon
200012	78x36x25mm	5/16"-18Sx1"	Brown/Black	Nylon
200013	78x36x25mm	5/16"-18Sx1.5"	Brown/Black	Nylon



Part No.	Size	Stem thread	Colour	Material
200020	50x26x18mm	1/4"-20Sx1"	Black	Nylon
200021	50x26x18mm	1/4"-20Sx1.5"	Black	Nylon
200022	50x26x18mm	5/16"-18Sx1"	Black	Nylon
200023	50x26x18mm	5/16"-18Sx1.5"	Black	Nylon



Part No.	Size	Stem thread	Colour	Material
200030	58x32x16mm	1/4"-20Sx1"	Black	Nylon
200031	58x32x16mm	1/4"-20Sx1.5"	Black	Nylon
200032	58x32x16mm	5/16"-18Sx1"	Black	Nylon
200033	58x32x16mm	5/16"-18Sx1.5"	Black	Nylon



Part No.	Size	Stem thread	Colour	Material
200040	45x28x32mm	1/4"-20Sx1"	Black/yellow/red	Nylon
200041	45x28x32mm	1/4"-20Sx1.5"	Black/yellow/red	Nylon
200042	45x28x32mm	5/16"-18Sx1"	Black/yellow/red	Nylon
200043	45x28x32mm	5/16"-18Sx1.5"	Black/yellow/red	Nylon



Part NO.:200050
Size:78x36x30mm
Colour: Red/blue
Material:TPE



Part NO.:200060
Size:78x26x35mm
Colour: White/Black
Material:Nylon



Part NO.:200070
Size:65x35x32mm
Colour: Black
Material:Bakelite

INSERT GLIDES & BUMPERS





INSERT GLIDE

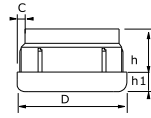

Part NO.	Size (mm)				Material
	D	h	h1	C	
240052	22x22	8.7	4	0.8	HDPE

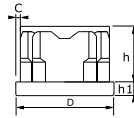
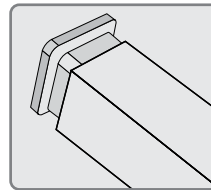
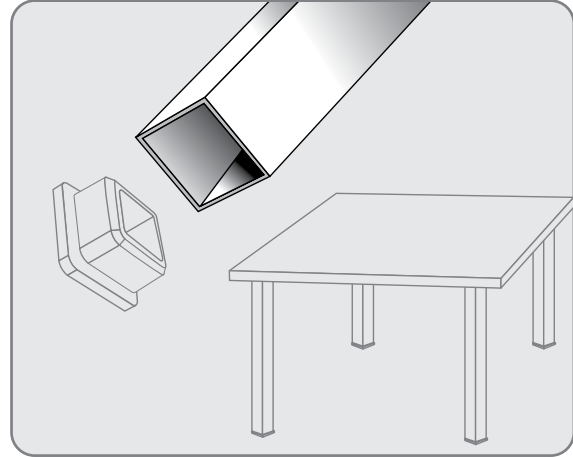

Part NO.	Size (mm)				Material
	D	h	h1	C	
240049	19x19	10.7	4	1.2	HDPE
240048	22x22	16.7	4	1.2	HDPE
240047	25x25	14.3	4	1.2	HDPE

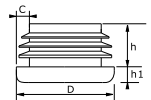

Part NO.	Size (mm)				Material
	D	h	h1	C	
240050	25x25	11	4	1.2-1.5	HDPE

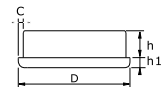

Part NO.	Size (mm)				Material
	D	h	h1	C	
240045	38x38	9.4	3.3	1.3	HDPE

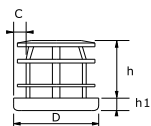

Part NO.	Size (mm)				Material
	D	h	h1	C	
240051	25x25	17.2	3.8	1.2-1.5	LDPE

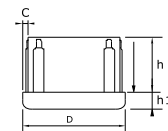

Part NO.	Size (mm)				Material
	D	h	h1	C	
240044	38x38	20	6.2	1.8	HDPE

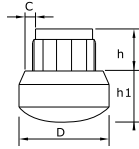

Part NO.	Size (mm)				Material
	D	h	h1	C	
240060	25.4x25.4	12	14.2	2	HDPE

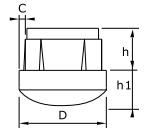

Part NO.	Size (mm)				Material
	D	h	h1	C	
240058	22.2x22.2	11	10	1.2	HDPE

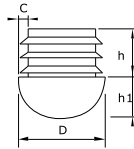

Part NO.	Size (mm)				Material
	D	h	h1	C	
240057	21.7x21.7	12	10	0.8-1	HDPE

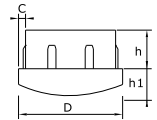

Part NO.	Size (mm)				Material
	D	h	h1	C	
240080	31.8x31.8	12	9.6	1.5	HDPE

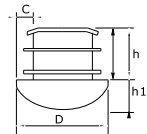

Part NO.	Size (mm)				Material
	D	h	h1	C	
240090	27.8x27.8	15.5	9.9	2.2	HDPE

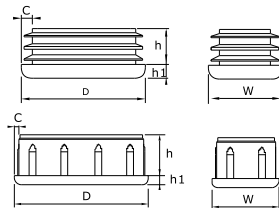

Part NO.	Size (mm)				Material
	D-W	H	h	C	
240067-1	50.8x25.4	15.8	3.3	1.5	HDPE
240069	57.6x25.4	13.8	4.5	1.2-1.5	HDPE
240069-1	38.3x22.8	11.4	4	1.8-2	HDPE

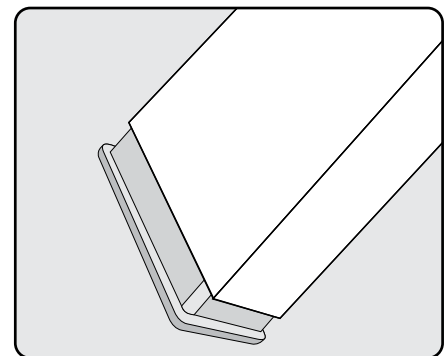

INSERT GLIDE

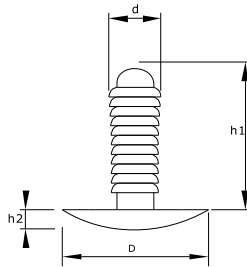

Part NO.	Size (mm)				Material
	D	h	h1	d	
240013-1	10.4	7	1.6	4.3	PA66
240013-2	12	12.2	1.5	7.1	PA66
240013-3	17.8	19	2	7.7	PA66
240013-4	18.8	29	3.2	7.7	PA66

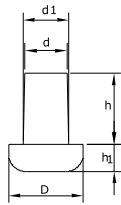

Part NO.	Size (mm)					Material
	D	h	h1	d	d1	
240010-1	12.8	10	4.7	6.2	6.5	PVC
240010-2	15.5	10.5	7.2	6.2	6.6	PVC
240010-3	19	9.1	9.3	7.8	8	PVC

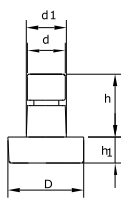

Part NO.	Size (mm)					Material
	D	h	h1	d	d1	
240011-1	12.7	10.5	4.4	6.3	6.6	PVC

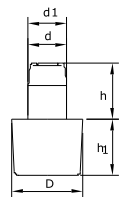

Part NO.	Size (mm)					Material
	D	h	h1	d	d1	
240011-2	12.7	10.3	9.8	6.5	7.1	PVC
240011-3	12.7	9.1	11.2	5.6	6	HDPE

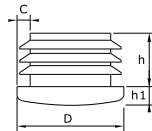
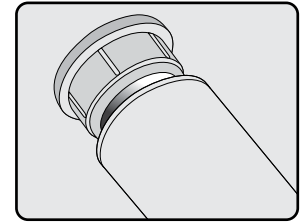
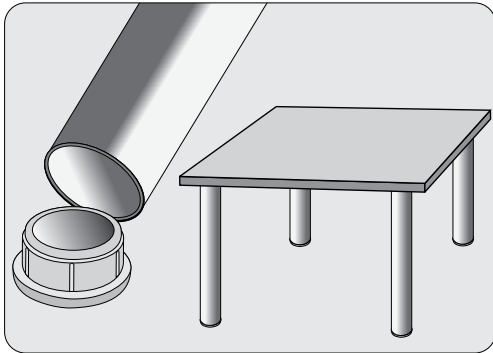

Part NO.	Size (mm)				Material
	D	h	h1	C	
240039	19	10	3.4	2.1-2.5	LDPE
240038	18.5	13	3	0.5-0.8	LDPE
240037	19	12.5	4	1.2-1.5	LDPE
240036	22	12	4	1.2-1.5	LDPE
240035	25	13	4	1.2-1.5	LDPE
240035-1	22	14	7.3	1.2-1.5	HDPE
240034	23	9	2.5	1-1.2	HDPE

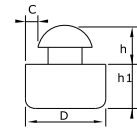

Part NO.	Size (mm)				Material
	D	h	h1	C	
240016	15.8	7.5	8.6	4.8	PVC

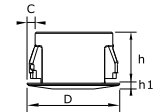

Part NO.	Size (mm)				Material
	D	h	h1	C	
240016-1	15.8	9.3	1.1	2	PA6

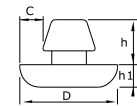

Part NO.	Size (mm)				Material
	D	h	h1	C	
240023	34.5	16	7.8	9	PVC

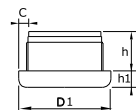

Part NO.	Size (mm)				Material
	D	h	h1	C	
240033	22	9.8	4	2.2	ABS
240032	31.2	11.1	5	2.2	ABS
240031	31.5	11	4.5	1.2	ABS
240030	38.1	9.4	4	1	ABS

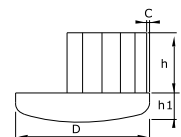

Part NO.	Size (mm)				Material
	D	h	h1	C	
240089	57	25.6	12.6	1	ABS

INSERT GLIDE

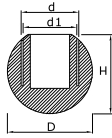

Part NO.	Size (mm)				Material
	D	h	h1	C	
240085	38.1	35.9	25.4	23.2	23.2

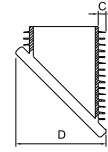

Part NO.	Size (mm)			Material
	D	C	Angle	
240056-1	46.3	3.75	45°	LDPE

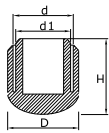

Part NO.	Size (mm)				Material
	D	H	d	d1	
240090	52.8	54.5	44.5	42.5	LDPE
240090-1	47.3	53.2	38.1	36	LDPE

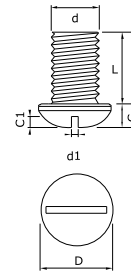

Part NO.	Size (mm)						Material
	D	d	d1	L	C	C1	
240088	38.1	1-1/2"-6	3.8	38.1	12.5	6.8	PP
240087	38.1	1"-8	3.8	38.1	12.5	6.8	PP

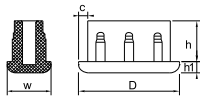

Part NO.	Size (mm)				Material
	D-W	h	h1	C	
240056	33.8x15	14	4	2	HDPE

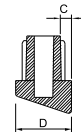

Part NO.	Size (mm)			Material
	D	C	Angle	
240063	20	3.9	18°	ClearABS
240063-1	21.4	3	10°	ClearPC
240063-2	21.4	3	23°	ClearPC

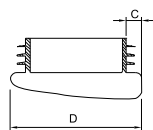

Part NO.	Size (mm)			Material
	D	C	Angle	
240056-2	47.6	5.4	5°	LDPE

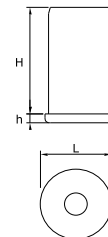

Part NO.	Size (mm)				Material
	Stem thread	L	H	h	
240120	1/4"-20S	25.4	12.7	0.8	PA6

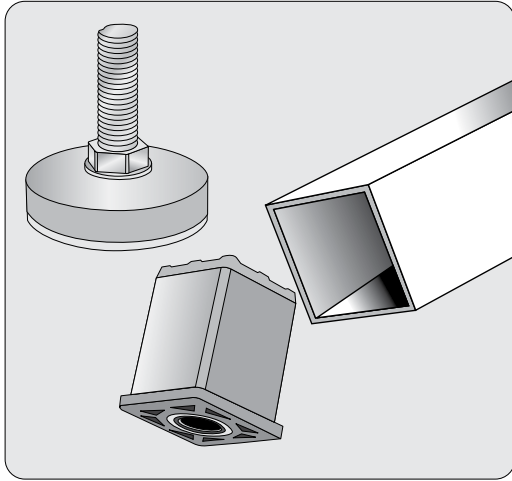

Part No.	Base dia.	Stem thread		Material
		Stem	Nut	
240130	19mm	M6	1/4"-20S	Nylon/HDPE
240131	22mm	M6	1/4"-20S	Nylon/HDPE
		M8	5/16"-18S	
240132	25mm	M6	1/4"-20S	Nylon/HDPE
		M8	5/16"-18S	
240133	32mm	M8	5/16"-18S	Nylon/HDPE
		M10	3/8"-16S	
240134	35mm	M8	5/16"-18S	Nylon/HDPE
		M10	3/8"-16S	
240135	50mm	M8	5/16"-18S	Nylon/HDPE
		M10	3/8"-16S	
		M12	1/2"-13S	

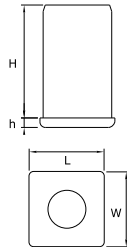

Part NO.	Stem thread	Size (mm)				Material
		L	W	H	h	
240110	1/2"-13S	25.4	25.4	37.3	3.3	PA6
240110-1	1/2"-13S	31.8	31.8	37.3	3.3	PA6

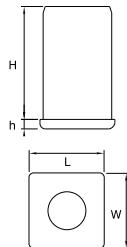
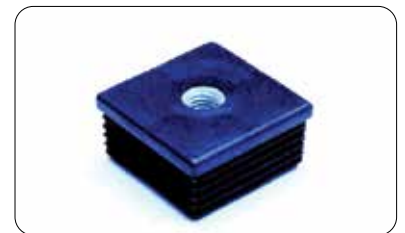

Part NO.	Stem thread	Size (mm)				Material
		L	W	H	h	
240170	M16	30	30	27	6	PA6

Part No.	Base dia.	Stem thread		Material
		Stem	Nut	
240160	19x19mm	M6	1/4"-20S	Nylon/HDPE
240161	22x22mm	M6	1/4"-20S	Nylon/HDPE
		M8	5/16"-18S	
240162	25x25mm	M6	1/4"-20S	Nylon/HDPE
		M8	5/16"-18S	
240163	32x32mm	M8	5/16"-18S	Nylon/HDPE
		M10	3/8"-16S	
240164	35x35mm	M8	5/16"-18S	Nylon/HDPE
		M10	3/8"-16S	
240165	50x50mm	M8	5/16"-18S	Nylon/HDPE
		M10	3/8"-16S	
		M12	1/2"-13S	

WIRE GROMMETS

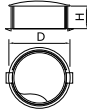

Part NO.	Size (mm)			Material
	D	H	Aperture	
240095	76.6	28.1	70	ABS

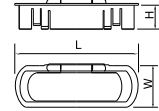

Part NO.	Size (mm)				Material
	L	W	H	Aperture	
240096-1	171.6	64.6	32.3	160.6x48.3	ABS

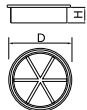

Part NO.	Size (mm)			Material
	D	H	Aperture	
240096-2	90	22.6	80	ABS

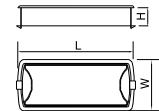

Part NO.	Size (mm)				Material
	L	W	H	Aperture	
240096	184	79.7	29	173x69	ABS

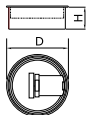

Part NO.	Size (mm)			Material
	D	H	Aperture	
240096	76	27	70	ABS

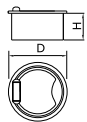

Part NO.	Size (mm)			Material
	D	H	Aperture	
240096-1	69.8	32	62	ABS

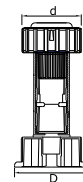

Part NO.	Size (mm)			Material
	D	d	ADJUST.H	
240040	59.6	47.9	113-152	ABS

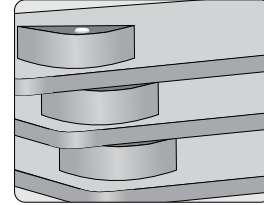
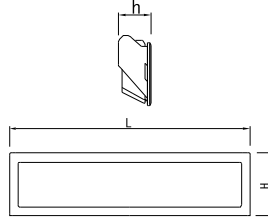

Part No.	Size (mm)			Material
	H	L	h	
280010	36	138	18.6	ABS
280010-1	32	111.1	20.1	ABS

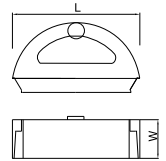

Part No.	Size (mm)		Material
	L	H	
260030	140	41.8	HDPE

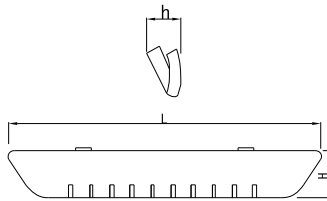

Part No.	Size (mm)			Material
	H	L	h	
280020	27.5	223	18.5	ABS

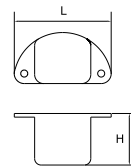

Part No.	Size (mm)		Material
	L	H	
260010	74.5	39.6	HDPE

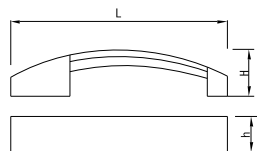

Part No.	Size (mm)			Material
	H	L	h	
280030	39.5	184.5	30	ABS

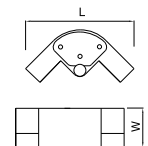

Part No.	Size (mm)		Material
	L	H	
260020	125	41	HDPE

CUSTOM MOLDED PARTS

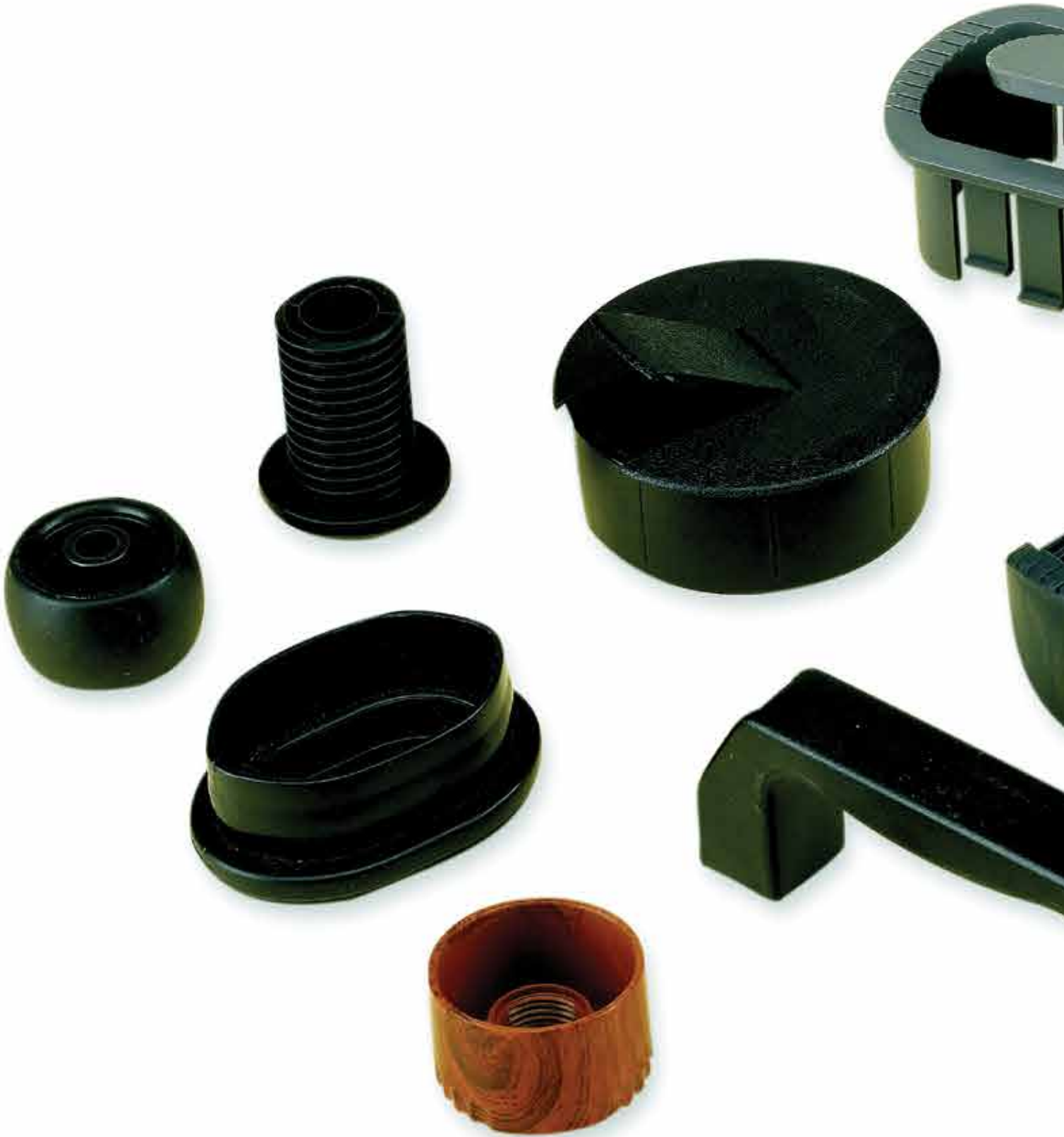



CUSTOM MOLDED PARTS

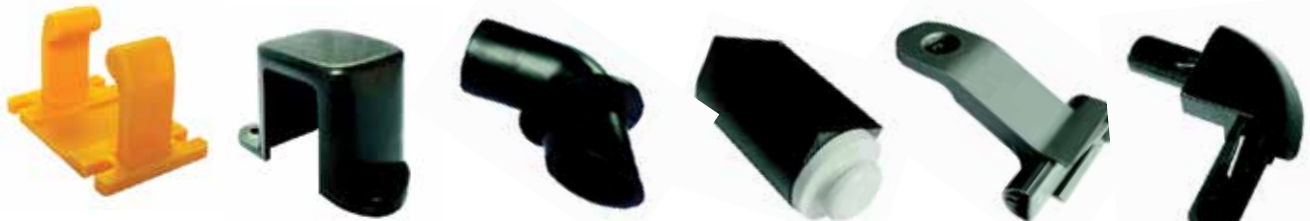

240120	240121	240122	240123	240124	240125
---------------	---------------	---------------	---------------	---------------	---------------



25mm				20mm 22mm	38mm
240086	240126	240127	240085	240090	

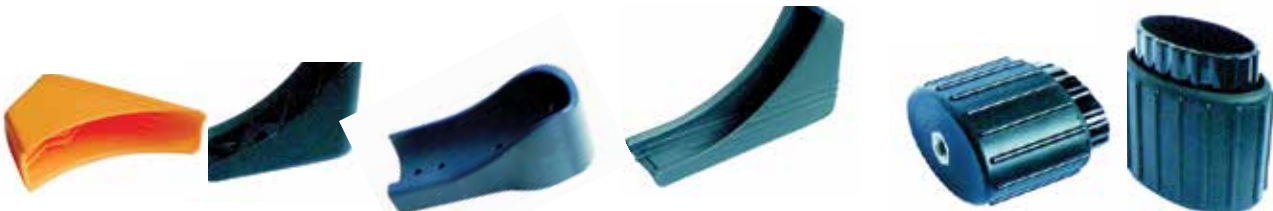

25mm	32mm	25mm	25mm	58x32mm
240091	240092	240093	240094	240102



240128	240129	240130	240131	240132
---------------	---------------	---------------	---------------	---------------



39x18mm	60x25mm	45x25mm	46x42mm	45x40mm	
240097	240098	240099	240100	240101	240133

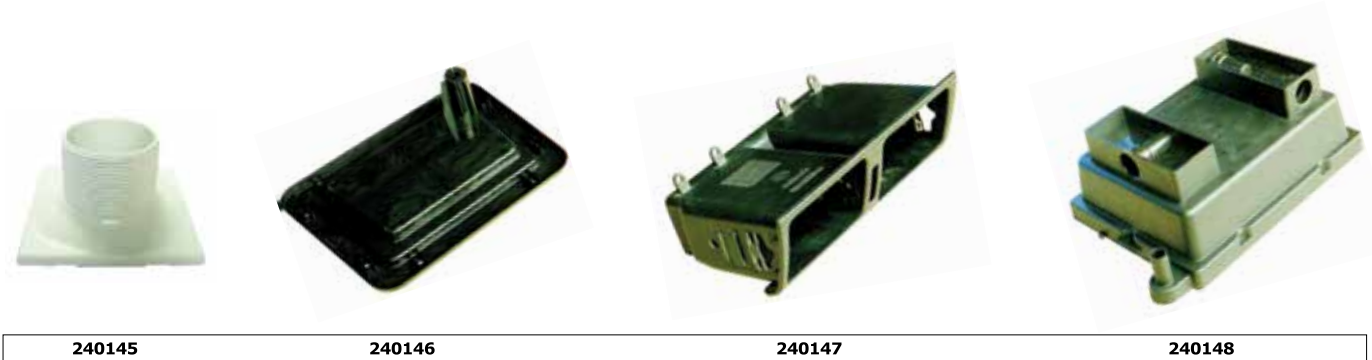

EXCEEDING EXPECTATIONS

Since FCI Molded Products amalgamation into The Accurate Group of Companies in 1990, we've always gone the "extra-mile" for our customers. We provide quality products, competitive pricing and responsive, knowledgeable staff who know how to keep your business moving.

FCI has supplied caps, glides and levelers on rapid turnaround to the furniture industry. Now one of the largest stocking distributors in Canada, our inventory is constantly expanding. We manufacture thousand of parts in plastic, steel, zinc and aluminum in an array of colours and finishes for multiple industries including; automotive, appliance, furniture and medical. In stock and on time, FCI is committed to providing quality goods and service at a competitive price.



HEAD OFFICE

FCI Molded Products Inc.
550 Applewood Crescent
Concord, Ontario, L4K 4B4
Telephone: (416) 798-7887
Toll Free: 1 (800) 849-4011
Fax: (905) 660-0179

BRANCH OFFICE

FCI Molded Products Inc.
240 Ardelt Ave
Kitchener, Ontario, N2C 2L9
Telephone: (519) 741-1104
Toll Free: 1 (800) 265-6178
Fax: (519) 741-1103

A DIVISION OF



**THE
ACCURATE
GROUP**
OF
COMPANIES